

User manual

Vacuklav[®] 41 B+ *Evolution* Vacuklav[®] 43 B+ *Evolution*

Steam sterilizer

from software version 3.240



EN

Dear customer,

We thank you for your confidence demonstrated by the purchase of this MELAG product. As an owner-run and operated family concern founded in 1951, we have a long history of successful specialization in hygiene products for practice-based use. Our focus on innovation, quality and the highest standards of operational reliability has established MELAG as the world's leading manufacturer in the instrument reprocessing and hygiene field.

You, our customer are justified in your demand for the best products, quality and reliability. Providing **“competence in hygiene”** and **“Quality – made in Germany”**, we guarantee that these demands will be met. Our certified quality management system is subject to close monitoring: one instrument to this end is our annual multi-day audit conducted in accordance with EN ISO 13485. This guarantees that all MELAG products are manufactured and tested in accordance with strict quality criteria.

The MELAG management and team.

CE 0197

Contents

1 General guidelines	5	Additional drying	27
Symbols used	5	Start time pre-selection	27
Formatting rules	5	Starting the program	28
Disposal	5	Program run	28
2 Safety	6	Manual program abort	29
3 Performance specifications	7	Program abort before the start of drying	30
Intended use	7	Program abort after the start of drying	31
Sterilization procedure	7	Program end	31
Type of the feed water supply	7	The approval process	32
Safety equipment	7	Removing the sterile material	32
Performance characteristics of sterilization programs	8	Storing sterile material	33
Program runs	9	8 Logging	34
4 Description of the device	10	Batch documentation	34
Scope of delivery	10	Output media	34
Views of the device	11	Using the CF card as an output medium	34
Service hatch	12	Using the computer as an output medium	35
Symbols on the device	12	Label printer as output medium	36
Load mounts	13	Outputting text logs automatically after program end (immediate output)	37
Energy-saving key	14	Subsequent log output	37
Colour touch display	14	Finding logs	39
LED status bar	16	9 Function checks	41
5 First steps	17	Vacuum test	41
Setup and installation	17	Bowie & Dick test	42
Feed water supply	17	10 Settings	43
Using the internal water storage tank	17	Logging	43
Switch on the device	18	Immediate log output	43
Opening and closing the door	19	Outputting graphic logs (optional)	44
Opening the door	19	Log output in English	45
Closing the door	19	Using the computer as an output medium	46
Manual door emergency-opening	19	IP addresses	47
6 Loading the steam sterilizer	21	Log formats	48
Preparing the load	21	User administration	49
Reprocessing instruments	21	Adding a user	49
Reprocessing textiles	21	Deleting a user	50
Loading the steam sterilizer	22	Changing the Admin PIN	51
Closed sterile containers	22	User authentication for sterilization	51
Soft sterilization packaging	23	Formatting the CF card	52
Multiple wrapping	23	Additional drying	53
Mixed loads	23	Intelligent drying	54
7 Sterilization	24	Water supply	54
Important information for routine operation	24	Date and time	55
Selecting the program	25	Brightness	55
Additional program options	27	Volume	55





View	56	Maintenance	63
Key tone	57	12 Pause times	64
Screensaver	57	Frequency of sterilization.....	64
Log printer MELAprint 42/44	58	Duration of the operating pause	64
MELAprint 60 label printer.....	58	Decommissioning	64
Sensitivity	58	Emptying the double jacket	64
Energy-saving mode	59	Transport	65
Switching off the display	59	Transport within the practice	65
11 Maintenance	60	Transport over long-distance / dispatch	65
Servicing intervals	60	Recommissioning after relocation	65
Cleaning	60	13 Malfunctions	66
Sterilization chamber, door gasket, mount, trays.....	60	Messages	66
Housing parts	61	Warning and error messages	66
Internal storage tank	61	14 Technical data	76
Avoiding staining	62	15 Accessories and spare parts	77
Replacing of the door gasket	63	Glossary	79
Checking and oiling the door lock	63		
Replacing the sterile filter	63		

1 General guidelines

Please read this user manual carefully before commissioning the device. The manual includes important safety instructions. Make sure that you always have access to digital or printed version of the user manual.

Should the manual no longer be legible, is damaged or has been lost, you can download a new copy from MELAG download centre at www.melag.com.

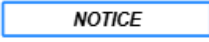
Symbols used

Symbol	Description
 WARNING	Indicates a dangerous situation, which if not avoided, could entail slight to life-threatening injuries.
 CAUTION	Indicates a dangerous situation, which if not avoided, could entail slight to moderate injuries.
 NOTICE	Indicates a dangerous situation, which if not avoided, could result in damage to the instruments, the practice fittings or the device.
 PLEASE NOTE	Draws your attention to important information.

Formatting rules

Example	Description
see Chapter 2	Reference to another text section within this document.
Log	Words or phrases appearing on the display of the device are marked as display text.

Disposal

MELAG devices are synonymous with long-term quality. When you eventually need to decommission your MELAG device, the required disposal of the device can be carried out by MELAG in Berlin. Simply contact your stockist.

Dispose of ▶**components**, spare parts, ▶**accessories**, ▶**equipment** and consumables that you no longer need properly. Comply with all relevant disposal regulations regarding potentially contaminated waste.

The packaging protects the device against transport damage. The packaging materials have been selected for their environmentally-friendly and recycling properties and can be recycled. Returning the packaging to the material cycle reduces the amount of waste and saves raw materials.

MELAG draws the operator's attention to the fact that they are responsible for deleting personal data on the device to be disposed of.

MELAG draws the operator's attention to the fact that they may be legally obliged (e.g. in Germany according to ElektroG) to remove used batteries and accumulators non-destructively before handing over the device, provided they are not enclosed in the device.

2 Safety



When operating the device, comply with the following safety instructions as well as those contained in subsequent chapters. Use the device only for the purpose specified in these instructions. Failure to comply with the safety instructions can result in injury and/or damage to the device.

Qualified personnel

- As with the preceding instrument reprocessing, only [▶competent personnel](#) should undertake sterilization using this steam sterilizer.
- The operator must ensure that the users are regularly trained in the operation and safe handling of the device.

Power cable and power plug

- Only the power cable included in the scope of delivery may be connected to the device.
- The power cable may only be replaced by an original spare part from MELAG.
- Only the power cable included in the scope of delivery may be connected to the device.
- The power cable may not be replaced by a cable determined to be insufficient.
- Comply with all legal requirements and locally-specified connection conditions.
- Never operate the device if the plug or power cable are damaged.
- The power cable or plug should only be replaced by [▶authorised technicians](#).
- Never damage or alter the power plug or cable.
- Never bend or twist the power cable excessively.
- Never unplug by pulling on the power cable. Always take a grip on the plug.
- Never place any heavy objects on the power cable.
- Ensure that the power cable does not become jammed in.
- Never lead the cable along a source of heat.
- Never fix the power cable with sharp objects.
- The mains socket must be freely accessible after installation so that the device can be disconnected from the electrical mains at any time if necessary by pulling the mains plug.

Spring safety valve

- Position the device in such a way that the faultless functioning of the spring loaded safety valve is guaranteed. The spring loaded safety valve must be able to move freely and not become stuck or blocked.

Opening the housing

- Never open the device housing. Incorrect opening and repair can compromise electrical safety and pose a danger to the user. The device may only be opened by an [▶authorised technician](#) who must be a [▶qualified electrician](#).

Notification requirement in the event of serious incidents in the European Economic Area

- Please note that all serious incidents that occur in relation to a [▶medical device](#) (e.g. death or a serious deterioration in a patient's state of health), which were presumably caused by the device must be reported to the manufacturer (MELAG) and the competent authority of the member state in which the user and/or the patient resides.

3 Performance specifications

Intended use

This steam sterilizer is intended for use in the medical field, e.g. general physician and dental practices. According to ▶EN 13060, this steam sterilizer is performing sterilization cycles of type B. It is designed as universal steam sterilizer for demanding sterilization tasks on the basis of the fractionated vacuum procedure. This guarantees the complete and effective penetration of the sterilization material with saturated steam. For instance, the sterilizer can be used for narrow lumen instruments, transmission instruments - wrapped or unwrapped - and textiles. The steam sterilizer is not intended for use on patients or in the patient environment. Typical users are doctors, instructed practice employees and service technicians.

▲ WARNING

Warning of material damage and injury

Any attempt to sterilize fluids can result in a ▶delay in boiling. This can cause damage to the device and/or scalding.

- Never use this device to sterilize fluids. It is not licensed for the sterilization of fluids.

Sterilization procedure

The steam sterilizer sterilizes on the basis of the ▶fractionated vacuum procedure. This guarantees the complete and effective wetting or penetration of the load with saturated steam.

This procedure enables the sterilization of loads common to a doctor's practice.

The steam sterilizer uses double jacket technology to generate the sterilization steam, i.e. the steam sterilizer is fitted with a separate steam generator combined with a double-walled sterilization chamber. After heating, steam is held constantly available in the double jacket. This gives the walls of the sterilization chamber a defined temperature and protects the chamber itself from overheating.

This procedure supports the quick ▶evacuation of the air from the sterilization chamber, the sterilization packages and instrument cavities. This allows you to sterilize large quantities of instruments or textiles in a very short time and achieve very good drying results.

Type of the feed water supply

The device works with a feed water one-way system. It uses fresh ▶feed water in the form of ▶demineralised or ▶distilled water for each sterilization procedure. The quality of the feed water is subject to permanent monitoring via integrated ▶conductivity measurement. If combined with a proper preparation of the instruments, this serves largely to prevent stain accretion on the instruments and soiling of the device.

Safety equipment

Internal process monitoring

A ▶process evaluation system is integrated in the electronics of the device. It compares the process parameters, such as temperature, time and pressure, during a program run. It monitors the parameters in terms of their threshold values and ensures a safe and successful program run. A monitoring system checks the device components of the device for their functionality and their plausible interaction. If one or more parameters exceeds pre-determined threshold values, the device issues warning or malfunction messages and if necessary, aborts the program. In the case of a program abort, follow the instructions on the display.

The device works with an electronic parameter control. This serves to optimise the total operating time of a program in dependence on the load.

Door mechanism

The device constantly checks pressure and temperature in the sterilization chamber and prevents the door from being opened during the program run and when over-pressure has built up. The motor-driven automatic door locking mechanism opens the door slowly by turning the locking spindle. This also holds the door whilst it opens. Even if pressure differences exist, the pressure equalisation takes place until the door is completely open.

Quantity and quality of the feed water

The quantity and quality of the ▶feed water is automatically checked before every program start.

Performance characteristics of sterilization programs

The results in this table show which inspections were performed on the steam sterilizer. The marked fields demonstrate compliance with all the applicable sections of the standard ▶EN 13060.

Type tests	Universal-Program	Quick-Program B	Quick-Program S	Gentle-Program	Prion-Program
Program type in accordance with EN 13060	Type B	Type B	Type S	Type B	Type B
▶Dynamic pressure test of the sterilization chamber	X	X	X	X	X
▶Air leakage	X	X	X	X	X
▶Empty chamber test	X	X	X	X	X
▶Solid load	X	X	X	X	X
▶Porous partial load	X	--	--	X	X
▶Porous full load	X	--	--	X	X
▶Simple hollow bodies	X	X	X	X	X
▶Product with narrow lumen	X	X	--	X	X
▶Single wrapping	X	X	--	X	X
▶Multiple wrapping	X	--	--	X	X
Drying ▶solid load	X	X	X	X	X
Drying ▶porous load	X	--	--	X	X
Sterilization temperature	134 °C	134 °C	134 °C	121 °C	134 °C
Sterilization temperature band	134-137 °C	134-137 °C	134-137 °C	121-124 °C	134-137 °C
Sterilization pressure	2.1 bar	2.1 bar	2.1 bar	1.1 bar	2.1 bar
Plateau period	5:30 min	5:30 min	3:30 min	20:30 min	20:30 min
X = complies with all applicable sections of the standard EN 13060					

Program runs

A program runs in three main phases: the de-aeration and heating up phase, the sterilization phase and the drying phase. After program start, you can follow the program run on the display. It shows the chamber temperature and pressure as well as the time until the end of sterilization / drying.

Program phases of a standard reprocessing program

Program phase	Description
1. De-aeration and heating phase	<p>De-aeration</p> <p>The de-aeration phase comprises of the conditioning and the fractionating phase. During conditioning, steam is repeatedly injected into and removed from the ►sterilization chamber. This generates over-pressure and the residual air is removed. Then, during fractionation, the mixture of air and steam is evacuated from the sterilization chamber and steam is injected. This method is also called the fractionated vacuum procedure.</p>
	<p>Heating</p> <p>The continued steam injection into the sterilization chamber leads to an increase in pressure and temperature, which continues until the program-specific sterilization parameters have been reached.</p>
2. Sterilization phase	<p>Sterilizing</p> <p>If the pressure and temperature correspond to the program-dependent nominal values, the sterilization phase begins. The corresponding program parameters (pressure and temperature) are held at sterilization level. The plateau time is indicated on the display.</p>
3. Drying phase	<p>Pressure release</p> <p>The sterilization phase is followed by pressure release from the sterilization chamber.</p>
	<p>Drying</p> <p>The sterile material is dried using a vacuum, so-called vacuum drying.</p>
	<p>Ventilation</p> <p>Upon program end, the sterilization chamber is filled with sterile air via the air filter and adjusted to the ambient pressure. A corresponding display message Ventilation is shown.</p>

Program phases of the vacuum test

Program phase	Description
1. Evacuation phase	The sterilization chamber is evacuated until the pressure for the vacuum test has been reached.
2. Equilibration time	An equilibration time of 5 min will follow.
3. Measurement time	The measuring time is 10 min. The pressure increase within the sterilization chamber is measured during the measurement time. The evacuation pressure and the equilibration time or measurement time are shown on the display.
4. Ventilation	The sterilization chamber is ventilated after the end of the measuring time.
5. Test end	The display shows the test result, the batch number, the total number of batches and the leakage rate.

4 Description of the device

Scope of delivery

Please check the scope of delivery before setting up and connecting the device.

- Vacuklav 43 B+ or Vacuklav 41 B+
- User manual
- User manual Accessories for small steam sterilizers
- Manufacturer's inspection report including declaration of conformity
- Warranty certificate
- Technical manual
- Record of installation
- Tray lifter
- Power cable
- 4x cover caps for niches for mounts in the side wall
- Allen key with which to open the door in an emergency
- Hose for emptying the interior water storage tank
- MELAG oil for door lock nut
- Test gauge TR16 for door lock nut

Views of the device

View from the front

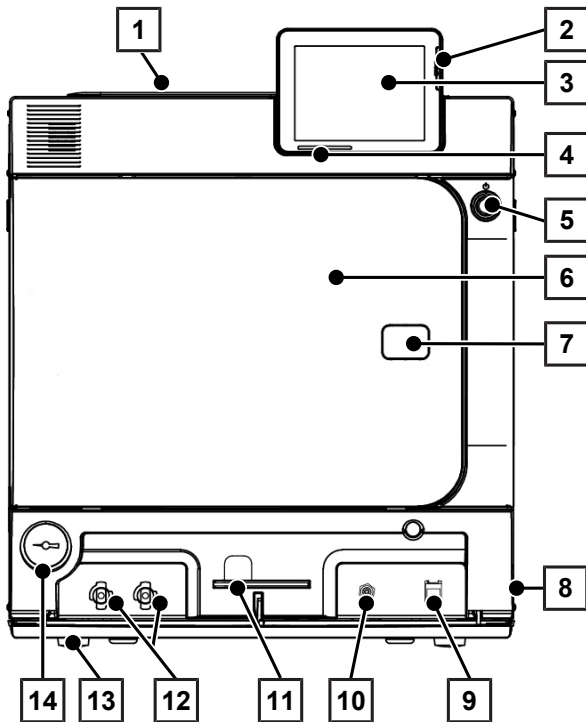

- 1 Tank lid of the internal storage tank
- 2 CF card slot
- 3 Colour touch display
- 4 LED status bar
- 5 Energy-saving key
- 6 Door (swings open to the left)
- 7 Opening for door opening in an emergency*)
- 8 Power switch (covered, accessible from the side)
- 9 Ethernet connection
- 10 Overheat protection reset button
- 11 Allen key 5 mm to open the door in an emergency
- 12 Drain valves for emptying the storage tank
- 13 Front device foot (adjustable)
- 14 Manometer for pressure display on the double jacket steam generator
*) behind cover

View from rear

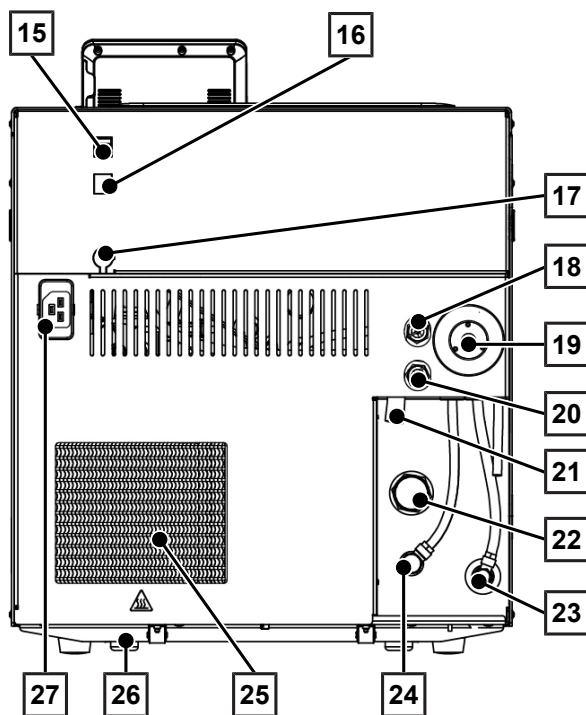

- 15 Ethernet connection
- 16 Ethernet connection, optional (upgradeable)
- 17 Optional connection of a Flex display
- 18 Spring loaded safety valve chamber
- 19 Sterile filter
- 20 Spring loaded safety valve double jacket
- 21 Emergency overflow
- 22 One-way outlet
- 23 Feed water intake (swivelling threaded fitting for hose Ø 8x1, alternatively straight)
- 24 Connection pressure release
- 25 Cooler
- 26 Rear device foot (fixed)
- 27 Power cable connection

View from the front, door open

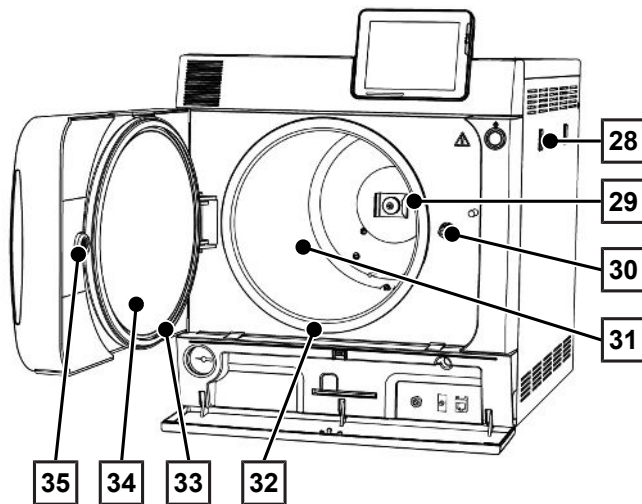

- 28 Mount for the water treatment unit for MELAdem
- 29 Spring clip for fixing mounts
- 30 Door spindle
- 31 Sterilization chamber
- 32 Chamber seal face
- 33 Door gasket
- 34 Round blank
- 35 Bushing

Service hatch

The service hatch is opened by pressing on the recess. The service hatch is closed again by closing and pressing on the recess.

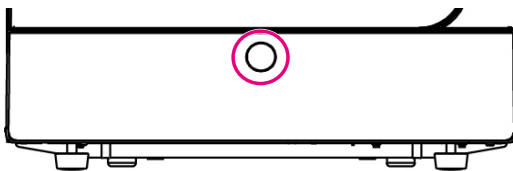

Symbols on the device



Manufacturer of the product



Date of manufacture of the product



Label as medical device



Article number of the product



Serial number of the product



Observe user manual or electronic user manual



Do not dispose of product in household waste



CE marking



Identification number of the notified body responsible for conformity assessment according to Pressure Equipment Directive 2014/68/EU



Identification number of the notified body responsible for conformity assessment according to Regulation (EU) 2017/745 on medical devices



Volume of the sterilization chamber



Working overpressure in sterilization chamber



Operating temperature in sterilization chamber



Electrical connection of the product: Alternating current (AC)



Draws your attention to a hot surface. Should the fan fail, the cooling unit fins can become hot.

Symbols on the power switch



Switching on device



Switching off device

Load mounts

A spring clip is located on the rear panel of the sterilization chamber to fix the mount. When using a mount Universal, slide the mount into the sterilization chamber to its fullest extent, until the mount snaps into the spring clip.

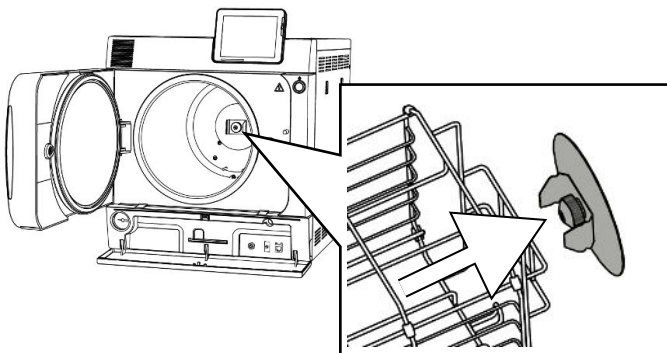

Energy-saving key

Pressing the energy-saving key activates the energy-saving mode and switches off the display. The double jacket will not be heated until the next program start. This corresponds to waiting time 2, see [Energy-saving mode](#) [▶ page 59].

Pressing the energy-saving key again will switch the display back on.

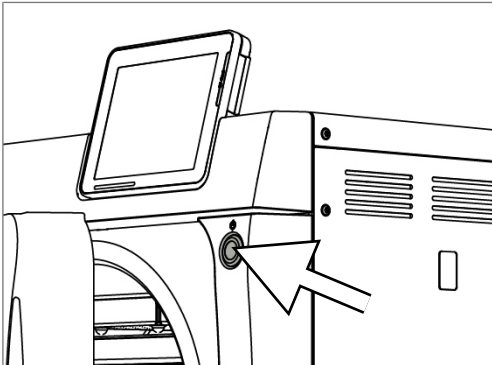

PLEASE NOTE

The energy-saving mode can not be activated during a program run.

State	Description
illuminated	Energy-saving mode can be activated.
not illuminated	Energy-saving mode is active or cannot be activated.





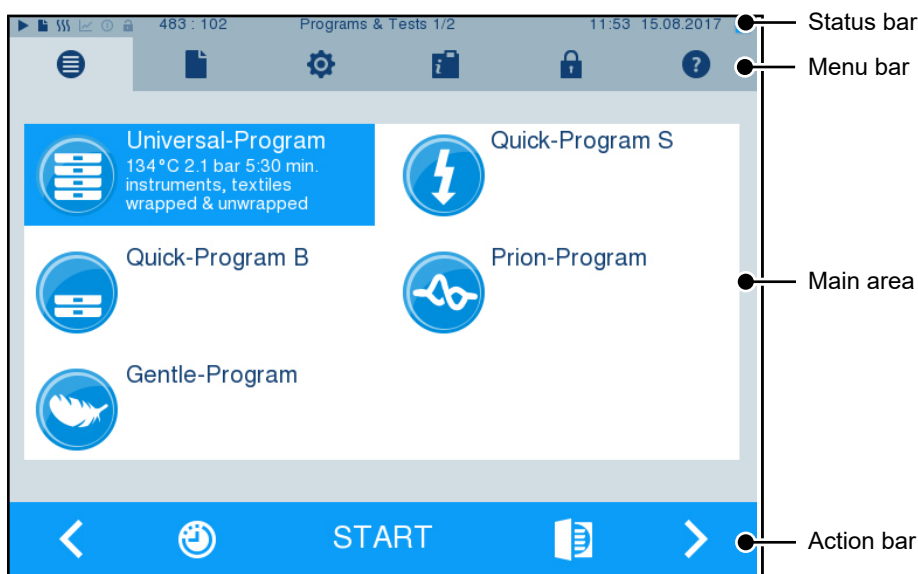

Colour touch display









The operating panel consists of a colour 5.7 inch touch display.



Symbols in the status bar	Description
	Program/tests Indicates whether a program/test is running
	Immediate output Indicates whether immediate output is activated/deactivated
	Additional drying Indicates whether additional drying is activated/deactivated
	Graphic logs Indicates whether the graphic log recording is activated/deactivated
	Energy-saving mode Indicates whether the steam sterilizer is currently in energy-saving mode
	Service area Indicates whether a service technician is logged-in to the service area

Symbols in the status bar		Description
	CF card status	Indicates whether a CF card has been inserted and whether a reading or writing action is in process

Symbols in the menu bar		Description
	Program/tests	Lists all reprocessing programs and tests, e.g. Vacuum test, Bowie & Dick test.
	Log output	Here you can display the entire log list or the list of logs from a restricted time (e.g. day, month). You can also delete specific log types and logs.
	Settings	Here you can perform various settings (e.g. date and time, brightness). It also enables one-time setting of the standard logging settings regarding log output.
	Info/status window	Displays information regarding the software version and device data, e.g. total number of batches, maintenance counter, log settings, log memory, and further technical values.
	Service area	Only for service technicians.
	Help menu	Depending on the window selected and the operating situation, gives information regarding operation or the function of the window currently selected.

Symbols in the action bar		Description
	Door open	Opens the door of the steam sterilizer
	Back	Navigates to the previous window
	Forwards	Navigates to the next window
	Cancel/return without saving	Navigates to the superordinate menu, leaves the window without saving
	Zoom (+)	Displays further details such as further values after a completed program
	Start time pre-selection	Navigates to the menu Start time pre-selection
	Delete	Deletes logs from the internal log memory/deletes the log printer or label printer stored as standard
	Search	Search for label printer / log printer
	Skip	Navigates to the next window without entry of the required data

LED status bar

The status bar on the lowest edge of the display indicates different situations with various colours.

Colour	Description
Blue	Standby, program running, drying has not yet begun
Green	Drying running, program completed successfully
Yellow	Warning message, software update is running
Red	Malfunction message, program not completed successfully

5 First steps

Setup and installation

PLEASE NOTE

For setup and installation, observe the information in the technical manual. This contains all building-side requirements.

Comply with the following for safe handling:

- Check the device after unpacking for any damage suffered during transport.
- The device should only be setup, installed and commissioned by MELAG authorised persons.
- Have the electrical connection and the water supply and waste water connections installed only by trained personnel.
- Using the optional electronic leak detector (water stop) minimises the risk of water damage.
- Do not install or operate the device in potentially explosive areas.
- Install and operate the device in a frost-free environment.
- The device is conceived for use outside the patient area. The device should be located a minimum of 1.5 m radius away from the treatment area.
- The documentation media (computer, CF card reader etc.) must be placed in such a way that they cannot come into contact with liquids.
- Position the device in such a way that the faultless functioning of the spring loaded safety valve is guaranteed. The spring loaded safety valve must be able to move freely and not become stuck or blocked.

Record of installation

As evidence of proper setup, installation and initial commissioning as well as your warranty claim, the record of installation must be completed by an authorised specialist and a copy sent to MELAG.

Feed water supply

Steam sterilization requires the use of ►distilled or ►demineralised water water, known as ►feed water. The ►EN 13060 specifies the guideline values to be observed.

The ►feed water supply is effected either via the internal feed water tank or via a separate water treatment unit (e.g. MELAdem 40 / MELAdem 47). The used feed water, so called waste water is either collected in the internal storage tank on the waste water side (left) and emptied manually or disposed of automatically via a building-side waste water connection.

NOTICE

When connecting an external feed water supply it is necessary to connect an external wastewater outflow as well.

There is a risk that hot wastewater might run through the emergency overflow.

For the initial filling of the steam-generating system, the device requires 2.5 l (Vacuklav 41 B+)/3.5 l (Vacuklav 43 B+) of feed water.

Using the internal water storage tank

Video tutorial

See also "Filling and emptying stand-alone autoclaves" (<https://www.melag.com/en/service/tutorial/autoclave>).



The internal storage tank holds max. 4.4 l. This volume of ►feed water is sufficient for up to 7 sterilization runs.

1. To fill the storage tank with fresh **▶feed water** remove the lid and fill the right-hand chamber of the storage tank with fresh feed water up to the MAX mark.

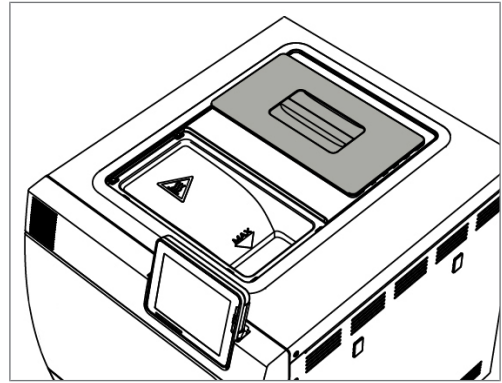

2. Set the feed water supply on the display to **INTERNAL**, see [Water supply](#) [▶ page 54].

Switch on the device

Video tutorial

See also "Operation" (<https://www.melag.com/en/service/tutorial/autoclave>).



The following must be fulfilled or present:

- ✓ The device is connected to the power supply.
- ✓ The feed water supply is secure.

1. Switch on the device at the power switch.

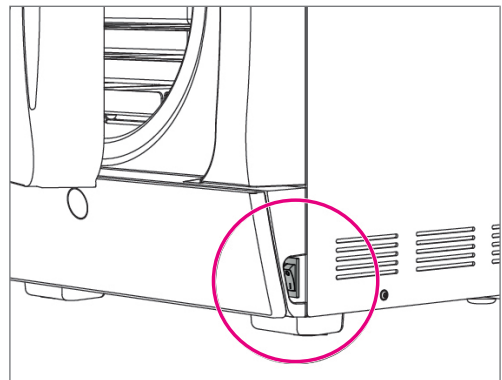

2. When the welcome screen appears, press CONTINUE. The display changes to the main menu.

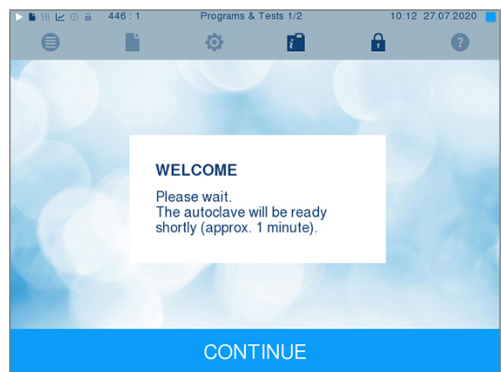

The feed water level is checked and pre-heated immediately after activation.

After device activation, a **▶pre-heating time** of approx. 9-13 min is required depending on the device type. This time is required for the pre-heating of the double jacket steam generator.

Opening and closing the door

The steam sterilizer is fitted with a motor-driven automatic door locking mechanism with a threaded spindle. Entry on the display is only possible when the door is closed.

Opening the door

The door is opened by pressing on the door symbol  on the display.

When opening the door, comply with the following instructions, so as to ensure faultless operation of the door locking mechanism.

- Never use force to open the door.
- Do not pull vigorously at the door to open it. The door unlocks automatically.
- Do not place any load on the door, e.g. by leaning on it.

PLEASE NOTE

The door is to be left open only whilst loading and unloading the steam sterilizer. Keeping the door closed saves energy.

Closing the door

To close the door, press it firmly inwards until the automatic door lock engages. After the door has been closed, the display returns to the program menu. The door is locked pressure-tight upon program start.

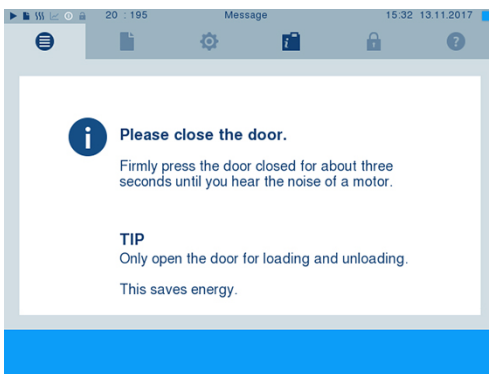

When closing the door, comply with the following instructions to guarantee faultless operation of the door locking mechanism:

- Do not slam the door.
- Keep pressing the door closed until the door lock engages.

Manual door emergency-opening

CAUTION

Warning of scalding

On opening the door, steam and hot water can escape from the sterilization chamber, e.g. if it is necessary to open the door immediately after the end of a program. This could result in scalding.

- Should steam be issued from the rear of the device after its deactivation, wait until the procedure has finished. Wait a further 5 min before opening the door.
- Stand to one side of the door and maintain sufficient distance.
- Allow the sterilization chamber to cool before removing the load.

In emergency situations e.g. power failure, the door can be opened in the following fashion:

1. If the steam sterilizer is still switched on, switch it off at the power switch (pos. a).
2. Remove the cover cap for the emergency door opening (pos. b) by pressing it out with a narrow slotted screwdriver, for example.

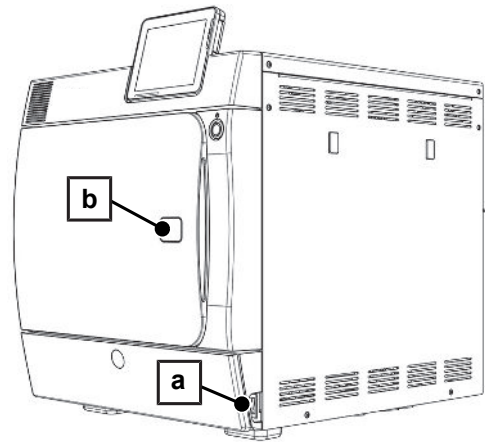

3. Insert the 5 mm Allen key included in the scope of delivery in the opening. The Allen key can be stored in the bracket behind the service hatch intended for this purpose.



4. Tighten the Allen key clockwise.

NOTICE

Do not open the door as long as the Allen key is still inserted, otherwise the plastic casing can break!

5. Remove the Allen key.
6. Open the door and return the cover cap.

6 Loading the steam sterilizer

Preparing the load

Always clean and disinfect properly before sterilization. Only in this way is it possible to guarantee the subsequent sterilization of the [▶load](#). The materials used, cleaning agents and reprocessing procedure are of decisive significance.

Comply with the following for safe handling:

- Only ever use packaging material and systems which have been cleared by their manufacturer for steam sterilization.
- Only use original MELAG articles or third-party articles approved by MELAG. No warranty can be provided for non-approved third-party articles, even if validation has been successfully carried out.

Reprocessing instruments

Unwrapped sterile material loses its sterility on contact with ambient air. If you intend to store your instruments sterilely, wrap them in suitable packaging before sterilization.

When [▶reprocessing](#) used and brand-new instruments, comply with the following:

- Always observe both the instrument manufacturer's reprocessing instructions and the relevant standards, guidelines and directives (in Germany, for example, from [▶RKI](#), [▶DGSV](#) and [▶DGUV Regulation 1](#)).
- Clean the instruments exceptionally thoroughly e.g. using an ultrasonic device or washer-disinfector.
- Rinse the instruments after washing and disinfecting, where possible with demineralised or distilled water, and then dry the instruments thoroughly with a clean, non-fuzzing cloth.
- Re-dry the spray, air and water channels using medical compressed air.
- Use only those care agents suitable for steam sterilization. Consult the manufacturer of the care agents. Do not use any water repellent agents or oils impermeable to steam. MELAG recommends the use of MELAG Care Oil Spray.
- When using ultrasound devices, care equipment for handpieces and washer-disinfectors, comply with the manufacturer's reprocessing instructions.
- Remove any residual disinfection and cleaning fluids to avoid corrosion. Otherwise, this could result in increased maintenance requirements and a restriction of the device function.

Reprocessing textiles

The incorrect reprocessing of textiles, e.g. a textile package can prevent steam penetration or produce poor drying results. This may result in the textiles **not** being sterile.

Comply with the following points when [▶reprocessing](#) textiles and placing the textiles in sterile containers:

- Comply with both the reprocessing instructions of the textile manufacturer the relevant standards, guidelines and directives (in Germany e.g. of the [▶RKI](#) and [▶DGSV](#)).
- Arrange the folds in the textiles parallel to each other.
- Stack textiles vertically wherever possible and not too closely together in the sterile container. This enables the development of flow channels.
- If textile packages do not remain together, wrap the textiles in sterilization paper.
- Only ever sterilize dry textiles.
- The textiles may not be permitted to come into direct contact with the sterilization chamber; otherwise they will become saturated with [▶condensate](#).

Loading the steam sterilizer

Effective sterilization and good drying is only possible if the steam sterilizer has been loaded correctly.

Ensure the following during loading:

- Insert trays or sterile containers in the sterilization chamber only with their appropriate mount.

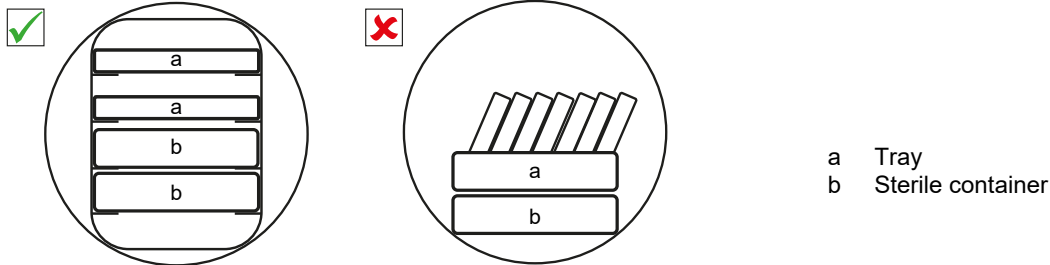

- Wherever possible, ensure the separate sterilization of textiles and instruments in separate sterile containers or sterilization packages. This leads to better drying results.
- The use of paper tray inserts can result in poor drying results.
- Use perforated trays such as those from MELAG. Only in this way can condensate drain off. Non-perforated bases or half-shells for holding the load lead to poor drying results.

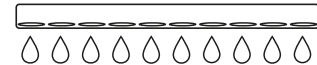

Packaging

Only ever use packaging materials and systems (sterile barrier systems) which fulfil the standard EN ISO 11607-1. The correct use of suitable packaging is important in achieving successful sterilization results. You can use re-usable rigid packaging systems or soft packaging such as transparent sterilization package, paper pouches, sterilization paper, textiles or fleece.

Video tutorial

See also "Loading" (<https://www.melag.com/en/service/tutorial/autoclave>).



Closed sterile containers

Please comply with the following when using closed sterile containers:

- Use aluminium sterile containers. Aluminium retains and conducts heat and thus accelerates drying.
- Closed sterile containers must be either perforated or have a valve on at least one side. MELAG sterile containers, e.g. MELAstore Box, fulfil the requirements for successful sterilization and drying.
- Wherever possible, ensure that sterile containers are only stacked on top of those of identical size, so that the condensate can run down their sides.
- Ensure that the perforations are not covered when stacking the sterile containers so that the condensate can drain off.

Soft sterilization packaging

▶Soft sterilization packages can be used in both sterile containers and on trays. Please comply with the following when using soft sterilization packages e.g. MELAfol:

- Arrange transparent sterilization packages on edge and close together. If this is not possible, place them with the paper side facing downwards.
- Do not place multiple soft sterilization packages flat on top of each other on a tray or in a container.
- When loading the steam sterilizer, make sure that either the film or paper sides of different pouches are facing each other.
- If the seal seam tears during sterilization, this could be caused by the choice of undersized packaging. Pack the instruments with larger packaging and perform sterilization again.
- Should the seal seam tear during sterilization despite sufficient bag size, adjust the sealing temperature on the sealing device or make a double seam.

Multiple wrapping

The device uses a fractionated vacuum procedure. This permits the use of ▶multiple wrapping.

Mixed loads

Please observe the following when sterilizing ▶mixed loads:

- Always place textiles at the top
- Sterile containers at the bottom
- Place unwrapped instruments at the bottom
- Place the heaviest loads at the bottom
- Transparent sterilization packages and paper packages on the top. Exception: At the bottom in combination with textiles

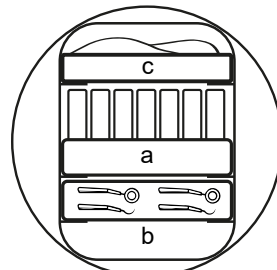
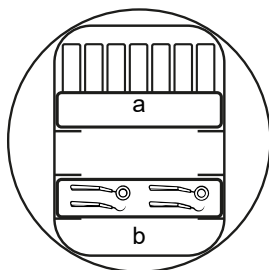

- a Wrappings
- b Heavy loads/instruments
- c Textiles

7 Sterilization

Important information for routine operation

Comply with the recommendations issued by the Robert Koch Institute (▶RKI) and the information contained in ▶DIN 58946-7.

Video tutorial

See also "Routine Checks" (<https://www.melag.com/en/service/tutorial/autoclave>).



Manufacturer's recommendation for the routine operation of type B steam sterilizers¹⁾

When is it necessary to make checks?	How should the checks be made?
Daily	<ul style="list-style-type: none"> • Visual check of the door gasket and the door lock for damage • Check the operating media (electricity, ▶feed water and water connection if necessary) • Check the documentation media (printer paper, computer, network) <p>MELAG recommends carrying out a steam penetration test using MELAcontrol Helix/SteriHero Helix/MELAcontrol Pro in the Universal-Program.</p>
Weekly	<ul style="list-style-type: none"> • Vacuum test <p>Tip: Before starting work in the morning – the device must be cold and dry</p>
Batch-related tests	<p>With "Critical B" instruments:</p> <ul style="list-style-type: none"> • MELAcontrol Helix/SteriHero Helix/MELAcontrol Pro must be included as ▶batch control in every sterilization cycle. <p>With "Critical A" instruments:</p> <ul style="list-style-type: none"> • The process indicator (type 5 in accordance with ▶EN ISO 11140) must be used as batch control with every sterilization cycle. <p>With "Critical A + B" instruments:</p> <ul style="list-style-type: none"> • MELAcontrol Helix/SteriHero Helix/MELAcontrol Pro must be included as batch control in every sterilization cycle. <p>This simplifies the working procedure and increases security. You can omit the daily steam penetration test with MELAcontrol Helix/SteriHero Helix/MELAcontrol Pro (see above). The use of another test system is possible. The number of the available test systems means that MELAG is not able to provide technical support when using a different system.</p>

PLEASE NOTE

Document the results of the tests. The test strips used need not be stored.

¹⁾in accordance with the current recommendations from the Robert Koch Institute

Selecting the program



Video tutorial

See also "Program selection" (<https://www.melag.com/en/service/tutorial/autoclave>).



Select the reprocessing program according to whether and how the ▶load is wrapped. It is also necessary to take into account the temperature resistance of the load. All sterilization and additional programs are displayed in the **Programs & Tests** menu. The following tables show you which program you use for which load and which additional programs are also available to you.

The max. weight per component is 2 kg for instruments or textiles.

Program	Suitable for		Max. load quantity		Operating time ^{*)}		Drying	
			Vacuklav 41 B+	Vacuklav 43 B+	Vacuklav 41 B+	Vacuklav 43 B+	Time-controlled	Intelligent ^{**)}
 Universal-Program 134 °C 2.1 bar 5:30 min	<ul style="list-style-type: none"> • Transmission instruments • Products with narrow lumen • Simple hollow bodies 	Instruments: <ul style="list-style-type: none"> • single wrapped • double wrapped • unwrapped 	6 kg	7 kg	approx. 23 min	approx. 25 min	12 min	4 - 30 min
		Textiles: <ul style="list-style-type: none"> • double wrapped 	9 kg with MELAstore ^{***)}					
Quick-Program B 134 °C 2.1 bar 5:30 min	<ul style="list-style-type: none"> • Transmission instruments • Products with narrow lumen • Simple hollow bodies 	Instruments: <ul style="list-style-type: none"> • single wrapped 	1.5 kg	1.5 kg	approx. 16 min	approx. 16 min	approx. 6 min	4 - 30 min
		<ul style="list-style-type: none"> • unwrapped No textiles and sterile containers	6 kg	7 kg				
 Quick-Program S 134 °C 2.1 bar 3:30 min	<ul style="list-style-type: none"> • Simple solid instruments • Simple hollow bodies 	Instruments: <ul style="list-style-type: none"> • unwrapped 	6 kg	7 kg	approx. 12 min	approx. 13 min	approx. 2 min	4 - 30 min
		No textiles and sterile containers						
 Gentle-Program 121 °C 1.1 bar 20:30 min	<ul style="list-style-type: none"> • Thermo-unstable equipment (e.g. plastic, rubber, textiles) • Products with narrow lumen • Simple hollow bodies 	Instruments: <ul style="list-style-type: none"> • single wrapped • double wrapped • unwrapped 	6 kg	7 kg	approx. 40 min	approx. 42 min	12 min	4-30 min
		Textiles: <ul style="list-style-type: none"> • double wrapped 	2 kg	2.5 kg				

Program	Suitable for		Max. load quantity		Operating time ^{*)}		Drying	
			Vacuklav 41 B+	Vacuklav 43 B+	Vacuklav 41 B+	Vacuklav 43 B+	Time-controlled	Intelligent ^{**)}
 Prion-Program 134 °C 2.1 bar 20:30 min	Instruments with more stringent sterilization requirements ^{****)} : <ul style="list-style-type: none"> • Transmission instruments • Products with narrow lumen • Simple hollow bodies 	Instruments: <ul style="list-style-type: none"> • single wrapped • double wrapped • unwrapped Textiles: <ul style="list-style-type: none"> • double wrapped 	6 kg	7 kg	approx. 38 min	approx. 39 min	12 min	4 - 30 min
			9 kg with MELAstore ^{***)}					

^{*)} without drying, with a full load and dependent on the load and setup conditions (such as e.g. cooling water temperature, if a fixed water connection is present, and mains voltage)

^{**)} Activation of intelligent drying subjects the drying phase to automatic monitoring and end the drying phase as soon as the load is dry.





^{***)} The drying was checked for the 9 kg load with MELAstore Box. The drying of other large weights (6 kg/7-9 kg wrapped) or other load configurations must be checked individually and locally. Additional drying may be required.

^{****)} The Prion-Program provides an extended plateau period at 134 °C to help reduce the risk of prion transmission - particularly when users comply with the applicable national or institutional requirements for handling potential prion contamination. The Prion-Program does not ensure complete inactivation of prions and does not claim prion inactivation.

Use the Prion-Program only as part of a validated overall reprocessing procedure, including thorough pre-cleaning and, where required, chemical prion decontamination in accordance with the applicable guidelines.

Use the Prion-Program only in accordance with the national or international guidelines applicable to you, e.g. "Hygiene requirements for the reprocessing of medical devices. Recommendation of the Commission for Hospital Hygiene and Infection Prevention (►KRINKO) at the Robert Koch Institute (►RKI) and the Federal Institute for Drugs and Medical Devices (►BfArM)" (2012, PMID: 23011095; German national guideline).

Always discard reusable medical instruments that have been in contact with high- or medium-risk tissue from patients with suspected or confirmed Creutzfeldt-Jakob disease - whether owned or borrowed. Prion proteins may be resistant to conventional sterilization processes!

Additional programs		Use/function
Vacuum test		For measuring the leakage rate, test with a dry and cold device (test without load)
Bowie & Dick test		Steam penetration test with special test package (available from specialist stockists)
Conductivity meas.		For manual measurement of the ►feed water quality
Drain		For draining and pressure release of the ►double jacket steam generator, e.g. for service, maintenance or before transport

Additional program options

Additional drying

The program-specific drying times ensure excellent drying of the sterile items. For difficult drying tasks, you can activate the additional drying – also subsequently during a running program, see [Additional drying](#) [▶ page 53].

Start time pre-selection

NOTICE

Warning of material damage to the device or the equipment

Unsupervised operation can result in material damage to the device and the equipment. Unattended operation is performed at the operator’s risk. In such a case, MELAG does not accept any liability.

- Never operate the device unattended.

This function enables you to select any program and start it at a time of your choice. The start time pre-selection is only active for the unique time and program selection. This means that after completion of the program, the pre-selected start time expires. You can switch off the steam sterilizer during the start time pre-selection. However, the steam sterilizer must be switched on before the timer runs out.

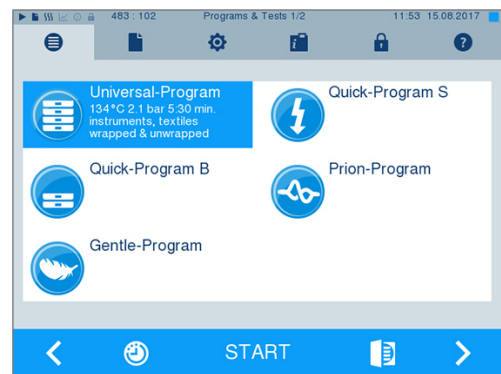

Note that this function is not possible for the Quick-Program S due to the confirmation prompt. To set a program start to a particular time, proceed as follows:

1. After selecting the program, press the  symbol in the action bar. The display switches to the settings window.

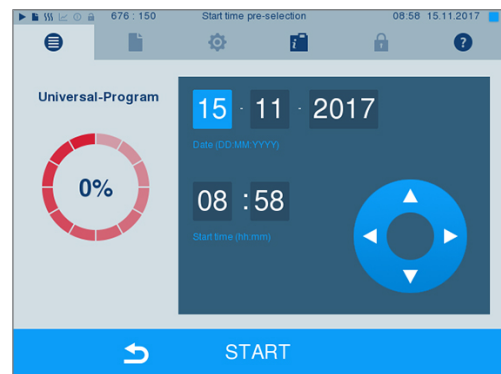

2. For example, to change the time, directly tap the parameter **Hour** or **Minutes**. The selected field is highlighted light blue.



3. Change the hour, for example, by pressing the  or  buttons.

4. Then press START. The display remains in the start time pre-selection window.

➔ After the start of the start time pre-selection no other menu apart from the **Info & Status** menu can be selected.

Starting the program

1. To start a program, press the START button.

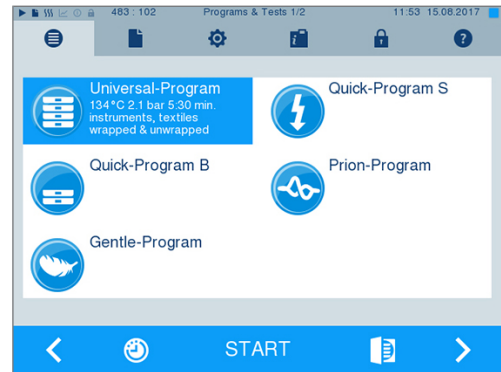

➔ The door closes pressure-tight and the device controls the amount of ▶feed water and its ▶conductivity.

2. With activated user authentication:

Enter the user PIN or, if possible, press the  button to skip input, see [User administration](#) [▶ page 49].

PLEASE NOTE: Use the function “Skip user authentication” only in an emergency.

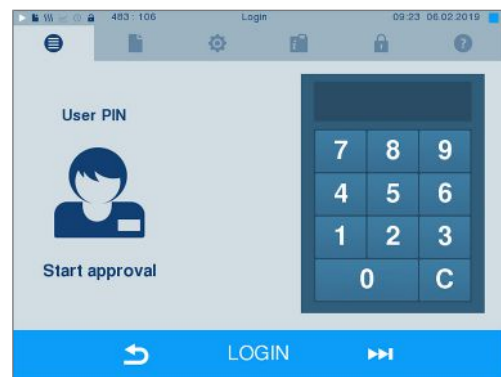

PLEASE NOTE

When starting the Quick-Program S, a warning and an acoustic signal indicate that this program is suitable only for the sterilization of unwrapped instruments. If the load contains unwrapped instruments only, confirm with YES to start the program.

Program run

A program runs in three main phases: the de-aeration and heating up phase, the sterilization phase and the drying phase. After program start, you can follow the program run on the display. It shows the chamber temperature and pressure as well as the time until the end of sterilization / drying.

De-aeration and heating up phase

During this phase, the steam will be injected and removed from the sterilization chamber (conditioning) to generate over-pressure and remove residual air. Then, during fractionation, the mixture of air and steam is evacuated from the sterilization chamber and steam is injected. This reduces the level of residual air in the sterilization chamber to a minimum. At the same time, the requirements for pressure and temperature are created for sterilization.

Sterilization phase

In the sterilization phase, pressure and temperature are held in the area required for sterilization.

The display indicates whether the sterilization phase has been completed successfully. The coloured ring and the LED status bar switches from blue to green as soon as the drying phase has been introduced.

The sterilization phase is unsuccessful if the user or the system (responding to a malfunction) aborts the program run. A system abort returns the steam sterilizer to a pressureless state. This explains why a system abort takes longer than an abort by the user.

Drying phase

The steam sterilizer provides excellent drying of the ▶load. Depending on the setting, drying is performed either via the time-controlled drying or the pre-set intelligent drying, see [Intelligent drying](#) [▶ page 54]. If difficult-to-dry items require better drying, you can undertake the following steps to improve drying:

- Load the steam sterilizer properly. Stand e.g. the transparent and paper sterilization packaging upright, see [Loading the steam sterilizer](#) [▶ page 22]. Use the optional package holder if necessary.
- Time-controlled drying: Activate function **Additional drying** in order to extend the drying time by 50%.
- Intelligent drying: Activate function **Additional drying** in order to restrict the criteria for ending the drying phase.

Monitoring the program run on the computer

You can follow the current progress of a reprocessing program on every computer in the practice network.

The following must be fulfilled or present:

- ✓ An IP address is assigned for the steam sterilizer.
 - ✓ The steam sterilizer is integrated into the practice network.
1. Open a web browser (we recommend Mozilla Firefox or Internet Explorer/Microsoft Edge) and enter the IP address of the steam sterilizer in the address bar of the web browser e.g. 192.168.57.41.
 2. Confirm with [ENTER]. Now you can display the program run or information about your steam sterilizer, e.g. serial number, device software version and selected values.

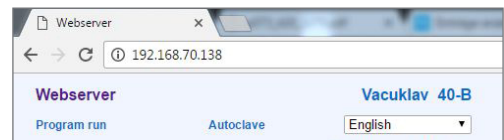

Manual program abort

You can abort a current program in all phases. If you abort the program before the end of the sterilization phase, the load is **not** sterile.



Depending on the time of the program abort, opening the door following a program abort can lead to the egress of hot steam or hot water.

This could result in scalding.

- Use aids to remove the tray (e.g. a tray lifter or protective gloves).
- Never touch the sterile material, the sterilization chamber or the door with unprotected hands. The components are hot.

Program abort before the start of drying

⚠ WARNING

Warning of contamination

If a program is terminated before drying starts, the load is **not** sterile.

- Re-wrap the load if necessary.
- Repeat the sterilization of the load.

Should you still wish to do so, proceed as follows to abort the program before drying:

1. Press CANCEL on the action bar.

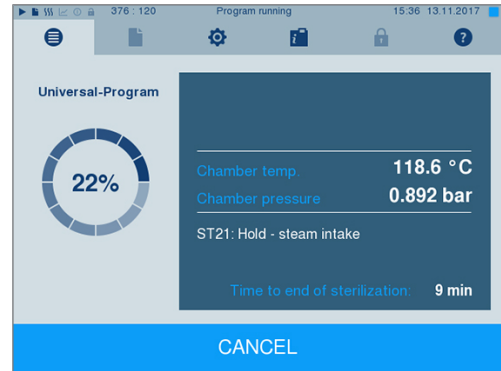

2. Confirm the security query with YES.

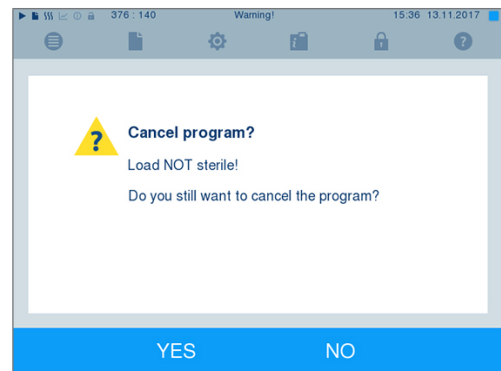

3. After a short time, you can open the door by pressing .

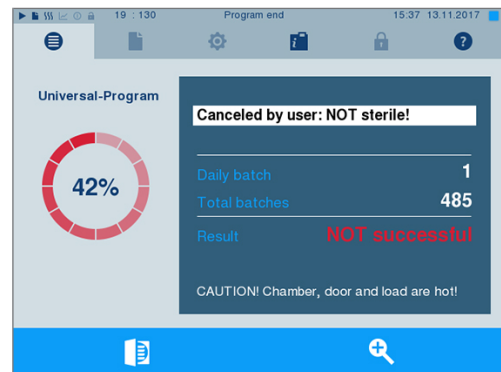

- ➔ The display shows a warning.
- ➔ Sterilization is marked on the log as **NOT successful**.

Program abort after the start of drying

Should you abort a program after drying has started, the sterilization is having been completed successfully. The steam sterilizer will not issue a malfunction message. You should expect insufficient drying, especially in the case of wrapped [sterile material](#) and a full load. Sterile storage requires sufficient drying. To ensure this, allow programs with wrapped sterile material to continue to the end of the drying phase as far as possible. Unwrapped instruments sterilized in a Quick-Program dry after being removed from their own warmth.

Proceed as follows to abort the program during drying:

1. Press STOP on the action bar.

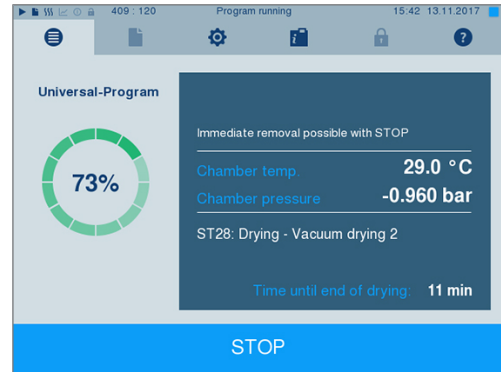

2. Confirm the security query with YES.

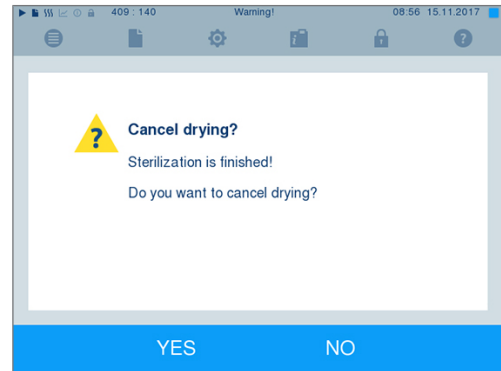

3. After a short time, you can open the door by pressing .

Program end

When the program has ended successfully, the corresponding message will be issued on the display. Before opening the door, you can view further values on the display from the program which has just completed, e.g. the plateau time

or [conductivity](#) etc. by pressing the zoom symbol .

- ▶ Press the door symbol  to unlock the door.

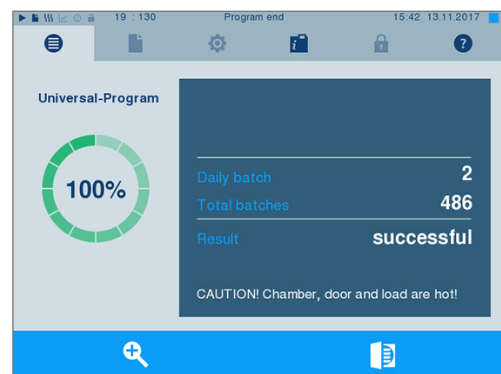

If automatic logging after program end is activated (= Immediate output) in the **Settings > Logging** menu, the log of the completed program will be outputted to the activated output medium after opening the door.

The approval process

Video tutorial

See also "Approving the sterilization batch" (<https://www.melag.com/en/service/tutorial/autoclave>).



In accordance with ▶RKI "Hygiene requirements for the reprocessing of medical devices", instrument preparation ends with the documented approval for storage and application of the ▶sterile material. The approval process consists of ▶batch indication and batch approval and must be performed by authorised and expert personnel. This is ensured by the activated user authentication. To do this, enter the user PIN, see [Settings](#) [▶ page 43].

PLEASE NOTE

Skipping user authentication means that the batch is not approved.

- Use the function "Skip user authentication" only in an emergency.

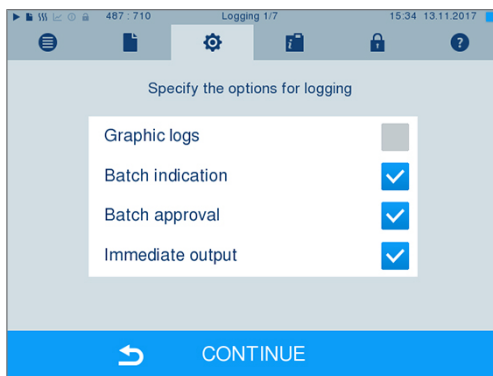

Batch indication includes checking the indicators carried in the reprocessing program (e.g. MELAcontrol Helix or MELAcontrol Pro). Approval of the indicator strip is possible only if it changes colour entirely.

Batch approval comprises the checking of the process parameters using the sterilization results on the steam sterilizer and the sterilization log as well as checking of the individual packaging for damage and residual moisture. The sterilization log records the approval of the ▶batch and any indicators. Depending on the setting in the user administration, approval for the ▶sterile material requires the user PIN of the person who provides approval for the batch and the indicators.

Removing the sterile material

WARNING

Warning of contamination

If packaging is damaged or has burst after sterilization, the instruments are unsterile.

- Re-wrap the load.
- Carry out the sterilization again.

CAUTION

Warning of burns

Touching hot metal surfaces can cause burns.

- Allow the device to cool sufficiently before opening.
- Never touch the load, the sterilization chamber or the door with unprotected hands.

If you remove the ▶sterile material from the device directly after the end of the program, it is possible that the instruments can be partially damp. According to the red brochure of the Arbeitskreis für Instrumentenaufbereitung (▶AKI), single drops of water (no puddles) that dry off within 15 min are considered tolerable residual moisture in practice.

Comply with the following specifications when removing the sterile material:

- Never use force to open the door. This could damage the device or result in the emission of hot steam.
- Hold the mount level when removing it from the device. Otherwise, the load could slide off.
- When removing the load from the device separately, ensure that the mount does not slide out unintended.
- Use a tray lifter to remove the tray.

Storing sterile material

The maximum storage time is dependent on the packaging and the storage conditions. Please observe the regulatory requirements for the storage period of [sterile materials](#) (in Germany e.g. [DIN 58953](#), Part 8 or the [DGSV](#) guidelines) as well as the following listed criteria:

- Store the sterile material in a dust-protected environment e.g. in a closed instrument cabinet.
- Store the sterile material in an environment protected against moisture.
- Store the sterile material in an environment protected against excess temperature variations.

8 Logging

Batch documentation

Video tutorial

See also „Process documentation“ (<https://www.melag.com/en/service/tutorial/autoclave>).



The batch documentation serves as proof of the successful conclusion of the program and represents an obligatory part of quality assurance. The device internal log memory saves such data as the program type, ▶batch and process parameters of all the programs completed.

To obtain the batch documentation, you can output the internal log memory and transfer its data to various output media. This can be performed immediately at the end of every program or at a later point, such as at the end of the day.

Capacity of the internal log memory

The device is equipped with an internal log memory where all data from completed reprocessing programs are stored. The capacity is sufficient for approx. 100 logs. If the internal log memory becomes almost full and at least one log has not been output via an activated output medium, the following warning **Internal log memory is almost full** will appear. Prepare the output media specified in menu **Settings > Logging**. Print the relevant logs (menu **Log output**).

Print any unprinted logs if message **Internal log memory full** appears. By pressing **YES**, the data in the device's log memory will be automatically deleted, except for the last 40 logs.

Output media

You are able to output and archive the logs of the completed programs on the following output media:

- ▶CF card
- MELAprint 60 label printer
- MELAprint 42/44 log printer
- A computer (via the practice network)

Any combination of the output media is possible. Log output on multiply activated media is performed successively. In its delivery state, the ▶CF card is activated as the output medium for text and graphic logs from the steam sterilizer. Automatic logging (=Immediate output) is thus activated.

Detailed information regarding the activation and setting of log output is to be found in the chapter [Settings, Logging](#) [▶ page 43].

Using the CF card as an output medium

NOTICE

Warning of material damage and data loss

When the CF card is pulled from the card slot prematurely or if it is treated improperly, data loss, damage to the CF card, the device and/or its software may occur.

- Never push the CF card in the slot with force.
- Never remove the CF card from the slot whilst it is being written or read. The square in the upper right-hand corner of the display lights up during reading and writing access.

The card slot for the CF card is located on the right-hand side of the display housing.

Proceed as follows in order to insert the CF card in the slot.

✓ The CF card is set as the output medium in the **Settings > Logging** menu.

1. Insert the CF card in the card slot fully with the raised finger edge pointing rightwards and to the rear.
If the CF card is inserted correctly, a blue square will illuminate in the right upper corner of the display.

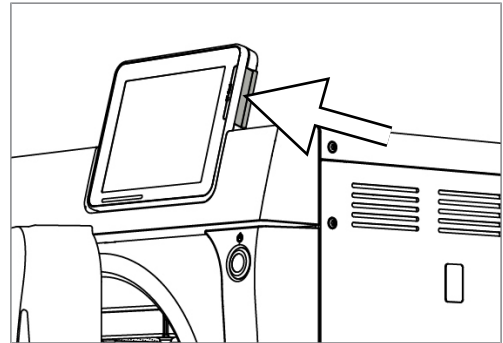

2. Check whether the CF card has been selected as the output medium.

Using the computer as an output medium

You can connect the steam sterilizer directly to a computer or integrate it in an existing (practice) network via FTP or TCP. The computer must be fitted with a RJ45 socket (LAN).

For more information on the requirements and setting the computer as the output medium, see [Settings, Logging](#) [▶ page 43].

Reading out a text log on the computer

All text logs can be opened and printed using a text editor, a word processing program or a spreadsheet program. Graphic logs can only be displayed with the MELAtace documentation software.

Each text log (e.g. .PRO, .STR, .STB) must be linked with the text editor to enable the computer to open them automatically with a text editor. For the meaning of the endings, see [Subsequent log output](#) [▶ page 37]. The following examples show how you can link the Windows 10 editor with a specific text log.

1. In Windows Explorer double click on the log file.
2. If the file ending is unfamiliar, Windows 10 will display the following message:

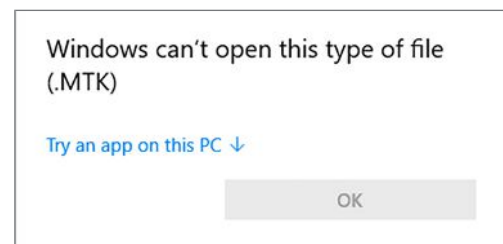

3. Select "Try an app on this PC".

4. Mark the editor and confirm with "OK".

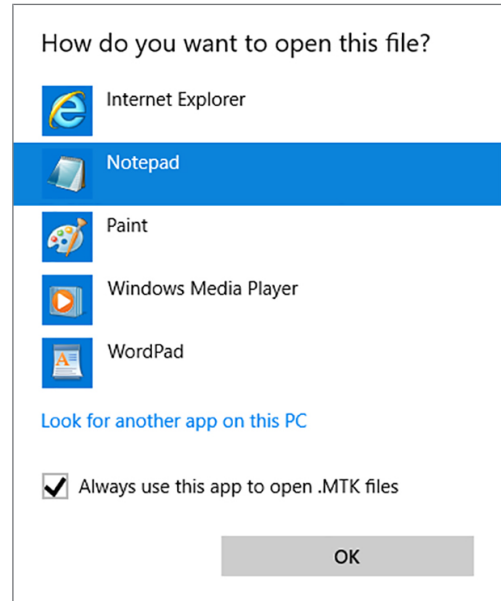

→ You can then open files with this ending via a double-click in Windows Editor.

Label printer as output medium

The use of a label printer facilitates batch traceability. By entering the following data, the sterile material can be assigned to the patient and the sterilization batch:

- Sterilization date
- Storage duration
- Batch number (daily / total batches)
- User ID (person who has authorised the sterile material for use)
- Device (type, serial number, program used)
- File name

Faultless packages containing sterile material are marked with labels after sterilization. As such, the preconditions for correct approval by the person conferred with the task of reprocessing are given. All information regarding the correct reprocessing process can be attributed to the instruments used in patient records.

PLEASE NOTE To facilitate easy assignation of a package marked with a label to a specific batch, the sterilization log file name must not be changed.

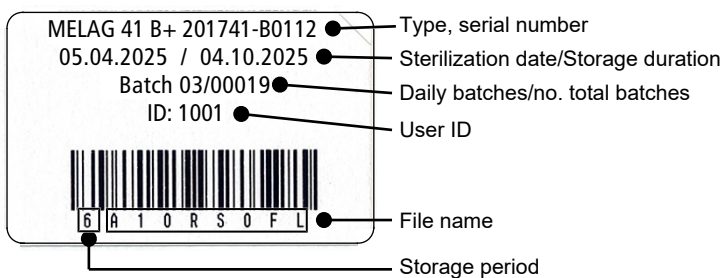

Outputting text logs automatically after program end (immediate output)

If you would like to output the associated text and graphic logs (optional) on an output medium immediately after the end of a program, use the **Immediate output** option. In its delivery state, the immediate output of the text and graphic logs via the CF card after program end is activated.

If the output medium selected for this purpose has not been connected, the logs are saved in the internal memory and a warning is issued. The steam sterilizer provides the option of outputting this log at the next possible opportunity. Graphic logs cannot be saved in the internal log memory; they are lost. For more information about the output of graphic logs, see [Outputting graphic logs \(optional\)](#) [▶ page 44].

The following points must be fulfilled for immediate output:

- The date and time have been set correctly.
- An output medium is selected and connected.
- Instant output is activated in the **Settings > Logging** menu.

For more information on setting the instant output with the desired output media, see [Settings, Logging](#) [▶ page 43].

Subsequent log output

The **Log output** menu provides the option of outputting text logs subsequently and independently of the point of the program end. You can set the output media yourself. By default, the output media that are also selected under **Settings > Logging** are preselected provided that automatic instant output is activated.

The **Log output** menu offers various opportunities for log output. All program logs present in the memory are displayed in the **Logging list**. You can sort the list according to number, date, time, program, and outcome by pressing on the column headings. Here is an overview of all possible output media.

Name	File ending	Description
Last log	.PRO	The log of the last successful completed program is output.
Logs of the day	.PRO	The log of the last successful program of the current day is output.
Logs of the week	.PRO	Logs of all successfully completed programs of the week – Monday to Sunday – will be output.
Logs of the month	.PRO	Logs of all successfully completed programs performed in the current month will be output.
All logs	.PRO	The logs of all successfully completed programs will be output.
Last fault log	.STR	The last malfunction log is output.
Fault logs of the day	.STR	The malfunction logs of the current day are output.
etc.	...	
Legend log file	.LEG	Contains an explanation of all abbreviations contained in the log.
Status log	.STA	A summary of all important settings and system states (e.g. counter, measured values).
Fault in standby	.STB	This log type is generated following malfunctions during a time at which no program was active.
System log	.LOG	A sort of logbook listing all malfunctions and changes to the system in order of their incidence.
Delete all logs	--	Deletes all logs stored in the internal log memory. Notice: All logs that were not previously output to another output medium will be deleted.

Output a log from the log list

Proceed as follows to output a specific log from the internal memory:

1. Navigate to the **Log output** menu, and select **Logging list**.

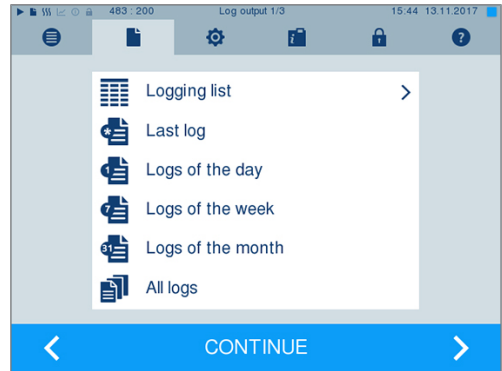

2. A list is displayed with all text logs that have been saved in the internal memory. To facilitate the search, you can filter the log sorting sequence by date, program or outcome by selecting the top line.

No.	Date	Time	Program	Result
484	10.08.2017	15:35	Universal-Program	ER_D
483	10.08.2017	15:34	Universal-Program	ER_D
482	10.08.2017	15:31	Universal-Program	OK_D
481	10.08.2017	14:25	Universal-Program	ER_D
480	10.08.2017	14:21	Universal-Program	OK_D

3. Select a log and press **CONTINUE**.
4. Select an output medium and press **OUTPUT**.

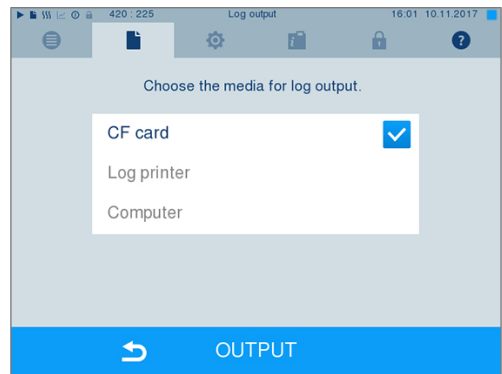

Output the daily, weekly logs, etc.

Proceed as follows e.g. to output all the logs of a week:

1. Navigate to the **Log output** menu, and select the **Logs of the week** option.

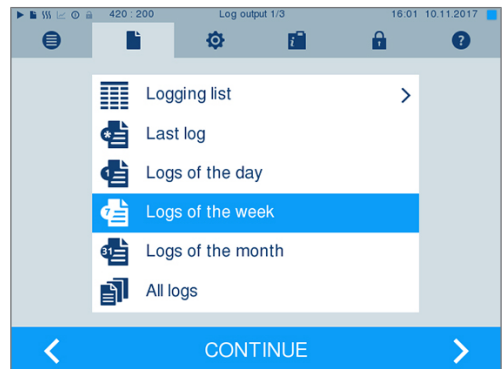

2. Press CONTINUE.
3. Select an output medium and press OUTPUT.

Proceed in a similar fashion to output the last log or all the logs of that day or month or all logs.

Finding logs

PLEASE NOTE

If possible, do not rename the directories because otherwise, logs will be stored both in the renamed directory and in the device directory automatically regenerated by the steam sterilizer.

Storage location for logs

When transferring the logs to a CF card, they will be stored in a separate folder in the main directory.

Transfer of the logs to a computer via the network and using the MELAG [FTP](#) server allows you to work directly in the FTP server program to determine directly where on your computer the device directory with the log files is to be saved. With output via [TCP](#) and MELAtrace, you can work directly in the program to determine the folder in which they are to be saved.

Log directory

A folder is created on all memory media (CF card or computer) after log output containing the encoded serial number of the steam sterilizer concerned. The folder name consists of five characters identical with the first five characters of every log (e.g. E00T7). This folder contains sub-folders with the month of log generation, e.g. 01_2025 for January 2025. This contains all logs generated by the steam sterilizer this month. The device directory is entered in the main directory on the [CF card](#).



The steam sterilizer checks the storage medium for every type of log output (immediate output after completed program run or transfer of several logs at once). If a directory does not exist, it automatically creates a directory for the device and the month. If the logs are output repeatedly to the same storage medium, a directory named “duplicate” is created there under the device directory.

Further information pertaining to the meaning of the file endings on the logs is available in section [Subsequent log output](#) [[page 37](#)].

Example log of a successfully completed program

<pre> ----- !0 01100ED0E001 !1 E00T717U.PRO ----- 10 MELAG Vacuklav 41 B+ ----- 15 Program: Universal-Program 20 Program type: 134 °C wrapped 25 Date: 09.03.2017 30 Daily batch: 14 Total: 01578 34 ID load: 1001 35 ID approval: 1001 36 Indicators changed: deactivated 37 Batch released: deactivated ===== 40 Universal-Program ended successfully 42 = = ===== 45 Temperature: 135.3 +0.25/-0.18 °C 50 Pressure: 2.17 +0.02/-0.01 bar 55 Plateau time: 05 min 30 s 60 Conductivity: 8 µS/cm (359:11.1) 65 Start time: 20:22:01 70 End time: 20:43:19 (21:18 min) ===== 80 SN:201441-B1051 ===== 81 MR V3.218 09.03.2017 82 Para V3.226 17.02.2017 83 BO V3.323 09.03.2017 ----- Step Time t[m:s] P[mbar] T[°C] SP-S 0:00 0:00 1002 96.3 SK11 0:13 0:13 1680 95.7 SK12 0:37 0:24 1285 104.8 SK11 0:46 0:09 1665 106.8 . . SK22 2:38 0:20 1284 116.6 SF12 3:12 0:34 499 112.7 SF13 3:42 0:30 1667 113.3 . SF43 8:25 0:24 1749 113.6 SH01 9:10 0:45 2780 130.5 SH02 9:31 0:21 2847 131.7 SS01 9:53 0:22 3065 134.0 SS02 15:23 5:30 3169 135.3 SA00 15:53 0:30 1292 112.1 SI02 17:33 1:40 79 57.9 . SB10 21:14 0:12 804 91.3 SB20 21:18 0:04 919 92.3 SP-E 21:18 0:00 925 92.3 >> Never change code on follow. line << 010041D8BE14B1319E55772A0DF975054F7EBF32 EE1372767ED3B3801EB10F3FB01A3212D41D7144 1C3B8B6474777962766F018680B68C56C219074F D6E7814D506F0A2F3077782541CC2CD05C425DA1 9A5EF5192C68174C868556542F7B8B05E97C6E46 16CDCFFA811E126FD67363FB74128A5F83AE6F37 F45A9E240C88615F1618D340060C1027205C83C2 >>Authentication of batch log<< ----- 0.00 0.0 0.0 0.0 ---.- 0.0 -edk---etm---etd---etp---etv---ett-END- </pre>	<pre> !0 Ident number !1 File name ----- 10 Steam sterilizer type ----- 15 Program name 20 Program sterilization parameters 25 Date 30 Daily and total batch number 34 User ID program start 35 User ID program end 36 Batch indication 37 Batch approval ===== 40 Control notification 42 Warning or malfunction message with program abort ===== 45 Sterilization temperature with max. deviations 50 Sterilization pressure with max. deviations 55 Sterilization time 60 Conductivity of the feed water 65 Time at program start 70 Time at program end ===== 80 Device serial number ===== 81 Current version of the device firmware 82 Current version of the device parameters 83 Current version of the user interface ----- Step – Program step Time – Time (minutes:seconds) which has elapsed since the program start t [m:s] – Duration (minutes:seconds) which a program step requires P [mbar] – Chamber pressure T [°C] – Chamber temperature Key for the program steps: SK – Conditioning SF – Fractionation SH – Holding SS – Sterilization SA – Pressure release ST – Drying SI – Intelligent drying SB – Ventilation SP-E – End Proof of authenticity (electronic signature)☐Should never be altered; decoding the code (by MELAG) indicates whether the data was generated on a MELAG steam sterilizer and has been changed. ----- Sensor measurement values are displayed here in the case of a malfunction. The values are helpful for a technician. </pre>
--	--

9 Function checks

Manual function checks

You can follow the program run on the display via the values displayed there. You can also use the logs recorded for every program to determine the success of a program. The test programs enable you to perform an additional function check at any time.

Vacuum test

The steam sterilizer can be checked for leakages in the steam system using the ▶vacuum test. This determines the leakage rate at the same time.

Perform a vacuum test in the following circumstances:

- Once a week in routine operation
- During commissioning
- Following longer operating pauses
- Following a malfunction (e.g. in the vacuum system)

Perform the Vacuum test with the steam sterilizer in a cold and dry state as follows:

1. Switch on the steam sterilizer at the power switch.
2. Working in the **Programs & Tests** menu, select Vacuum test and press START.

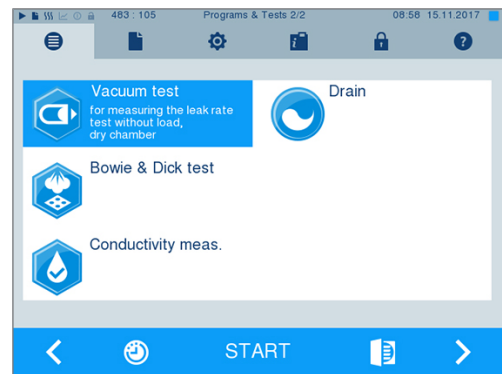

→ The leakage rate is shown on the display after the vacuum test has been completed. If the leakage rate is higher than 1.3 mbar, a corresponding message will appear.

Bowie & Dick test

The ▶**Bowie & Dick test** serves as evidence of steam penetration of ▶**porous materials** such as e.g. textiles. You can perform a routine function check for evidence of steam penetration. To do so, use the **Bowie & Dick test** program with a suitable test system, e.g. MELAcontrol Bowie & Dick Test. Depending on the application, use either a test system for hollow-body instruments or for porous loads (laundry, etc.). Combination test systems can also be used. Perform the Bowie & Dick test in accordance with the test system manufacturer's specifications.

1. Switch on the steam sterilizer at the power switch.
2. Place the test system in the sterilization chamber of the steam sterilizer and close the door.
3. In the **Programs & Tests** menu, select **Bowie & Dick test** and press **START**.



Evaluation of the indicator following the colour change

Depending on the manufacturer batch, indicators often exhibit differing intensities in the colour change resulting from different lengths of storage or other influences. Of crucial importance for evaluating the Bowie & Dick test is not the strength of contrast in the colour change on the test sheet, but the uniformity of the colour change on the indicator. If the indicator indicates an equal distribution of colour change, the de-aeration of the sterilization chamber is without fault. If the indicators are uncoloured or exhibit less colour in the centre in comparison to the end, de-aeration was insufficient. In this case, contact the authorised technician.

10 Settings

Logging

All settings pertaining to the output of text and graphic logs i.e. output medium, log format, immediate output etc. are performed in menu **Settings > Logging**.

To this end, you are led through a settings wizard.

Immediate log output

In its delivery state, the immediate output of the text and graphic logs via the CF card is activated.

Deactivating immediate output

If you do not want the log to be output directly after the end of the program but rather once a week, you can deactivate the immediate output as follows:

- ✓ You are in the **Settings > Logging** menu.
1. Remove the check mark in front of the **Immediate output** option.
 2. Press repeatedly on CONTINUE until you reach the summary window.
 3. Press SAVE to accept all settings and leave the menu.

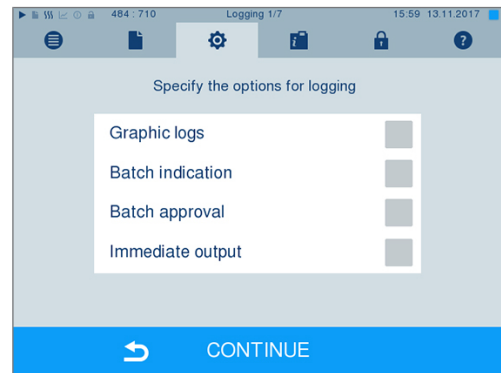

Outputting graphic logs (optional)

PLEASE NOTE

Graphic logs cannot be saved in the internal log memory. A subsequent output of graphic logs is thus not possible.

If you wish to output a graphic log (optional) in addition to a text log, proceed as follows:

- ✓ You are in the **Settings > Logging** menu.
 - ✓ Immediate output is activated.
1. Set a check mark next to the **Graphic logs** option and check whether the check mark is also set next to the **Immediate output** option.
 2. Press CONTINUE and select the CF card and/or computer as an output medium.
 3. If necessary, change the intervals and press CONTINUE.
 4. Working in this window, check whether at least one of the two output media have been selected for text logs.
 5. Check whether the activated output medium is connected (computer) or has been inserted (CF card).
 6. Press repeatedly on CONTINUE until you reach the summary window.
 7. Press SAVE to save the setting.

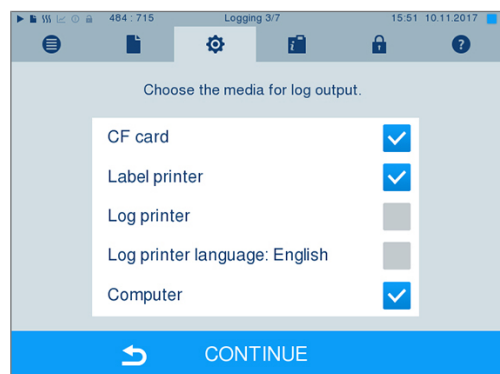
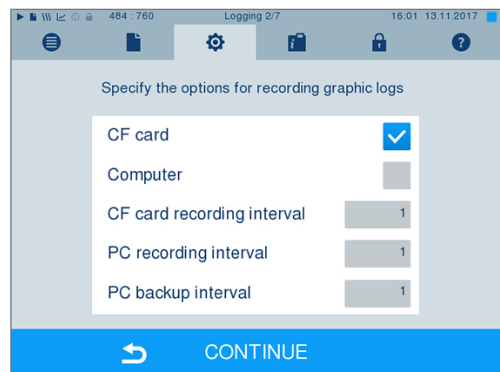
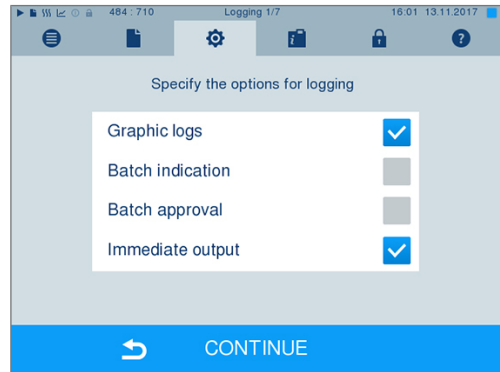

Explanation of the possible settings for graphic recording:

Interval	Description
CF card recording interval	in seconds – Indicates the time intervals in which the program curve is recorded on the ▶CF card. The smaller the time interval, the more exact the curve. In the example, the time interval is set at one second.
PC recording interval	in seconds – Indicates the time intervals in which the program curve is recorded if the computer is selected as output medium. The smaller the time interval, the more exact the curve. In the example, the time interval is set at one second.
PC backup interval	in seconds – Indicates the time interval in which the graphic data from the steam sterilizer is saved on the computer. In the example, the backup interval is set to one second.

Log output in English

If you want to print all text logs on the MELAprint log printer in English, proceed as follows:

- ✓ The text log should be printed in English, regardless of the language of the graphical user interface.
 - ✓ You are in the **Settings > Logging** menu.
1. Press CONTINUE repeatedly until you reach the window for selecting the output medium.
 2. Select **Log printer** as the output medium.
 3. Additionally, select **Log printer language: English**.

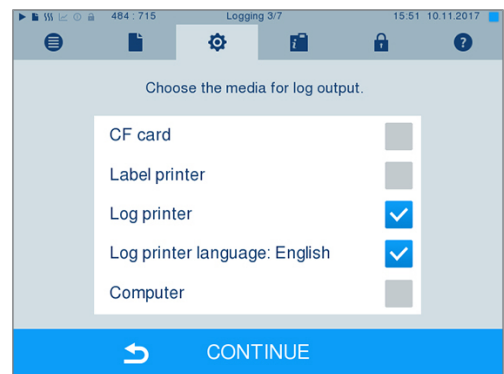

4. Press repeatedly on CONTINUE until you reach the summary window.
 5. Press SAVE to accept all settings and leave the menu.
- ➡ The text logs will be printed in English on the MELAprint log printer.

Using the computer as an output medium

Log transmission can be performed via an FTP server / service or TCP. The following section shows how to set the desired connection:

- ✓ You are in the **Settings > Logging** menu.
- ✓ The steam sterilizer is connected to a computer via a network cable (RJ45).
- ✓ Depending on the output type, an FTP server / service or a suitable program (e.g. MELAtrace) is installed.

1. Press on CONTINUE until you reach the window for selecting the output medium.

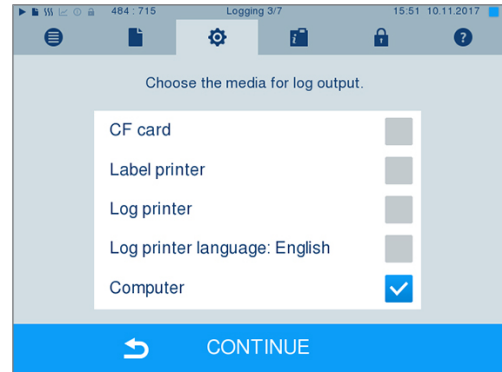

2. Select the computer as an output medium and press CONTINUE.

➔ The selection window opens and asks whether the connection to the computer should be effected via FTP or TCP.

Connection via FTP

- ✓ An FTP server or an FTP service is installed on the computer.

1. Select **Connection via FTP**. The lower pushbutton displays the current user data settings (standard user name: Year of construction + manufacture number; Password MELAG12345).



2. Press this pushbutton to change the pre-set TCP user data.

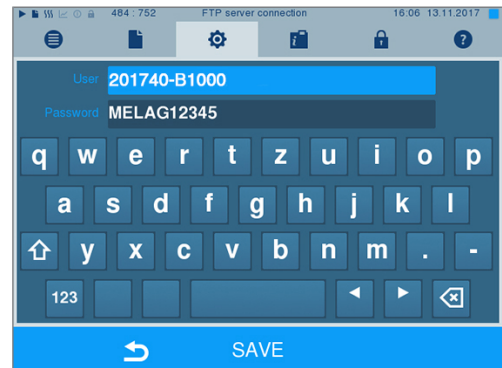

3. Enter the user name and password.

4. Confirm with SAVE.

Connection via TCP

✓ A suitable documentation software e.g. MELAtrace is installed.

1. Select **Connection via TCP**. The TCP port currently set is displayed on the lower pushbutton (Standard TCP port: 65001).



2. Press on the lower pushbutton to change the pre-set TCP port.

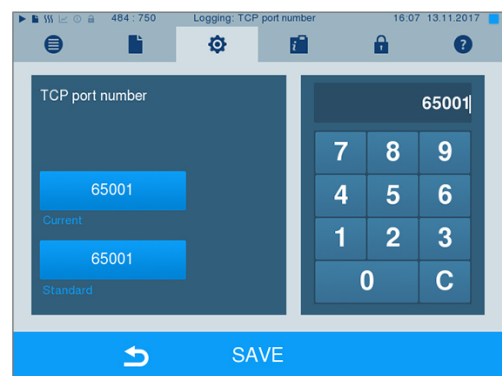

3. Delete the most up-to-date TCP port using button 'C'; enter another TCP port.

4. Confirm with SAVE.

IP addresses

PLEASE NOTE

The setting up of the (practice) network will require in-depth understanding of the network technology. Errors in the handling of IP addresses can result in malfunctions and data loss in your practice network.

- IP addresses may only be set by the (practice) network system administrator.

As a standard, the device is assigned IP addresses in the factory, which all belong to a common network with the subnet mask stated in the following.

Device	IP address	Remarks
Steam sterilizer	192.168.40.40	Pre-set ex works
Computer	192.168.40.140	Pre-set ex works
MELAprint 42/44 log printer	192.168.40.240	Pre-set ex works
MELAprint 60 label printer	192.168.40.160	Pre-set ex works
Gateway	192.168.40.244	Not relevant within a network
Subnet mask	255.255.255.0	Possibly to be adopted by customer network

When integrating the device into an existing (practice) network, the following requirements must be met:

- ✓ The IP addresses listed in the table have not yet been assigned in the (practice) network.
- ✓ The device cannot be automatically administered in a dynamic (practice) network (i.e. a DHCP network).

1. Select the **Settings > Logging** menu.
2. Working in the logging assistant, navigate to the window in which the IP addresses of the individual device are listed.

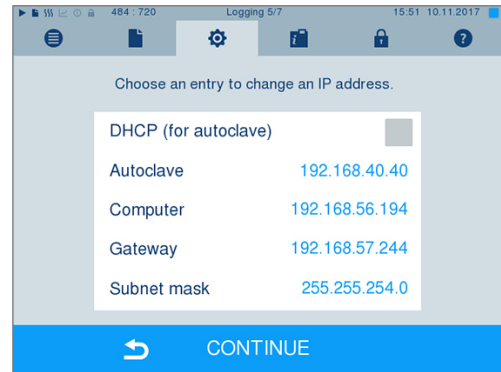

3. Select the steam sterilizer [Autoclave], for example.

4. Press the number block that you wish to change.



5. Press the button 'C' to delete the digits. Enter a new number block.
6. Press SAVE to accept all settings and leave the menu.
7. Proceed in a similar fashion with the other device that are to be integrated in the network.

Log formats

Different data are issued depending on the nature of the log format.

- ▶ The log format is determined under **Settings > Logging**.

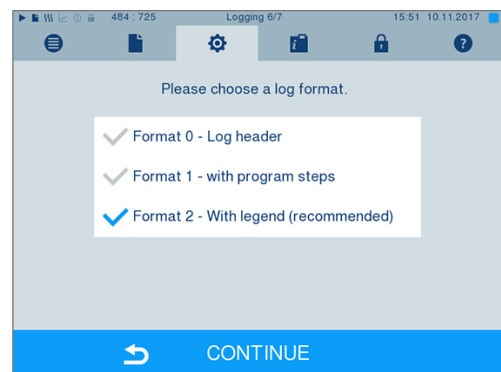

You can choose between the following formats:

Format	Description
Format 0	Short form – only the log header is output.
Format 1	The log header and the program steps are output.
Format 2	Standard format – in addition to the log header and the program steps, a key is displayed explaining the individual program steps. In logs output via the log printer MELAprint, the corresponding legend row is always located under the row to which it refers.

User administration

An ID and individual user PIN can be issued to every user with which to authenticate him/herself, so as to enable reliable traceability via the clearance process. You can determine the necessity of user authentication via a PIN in the **User administration** menu. Activation of this option documents the user ID and the outcome of the approval procedure in the log header.

Adding a user

1. Select the **Settings > User administration** menu.

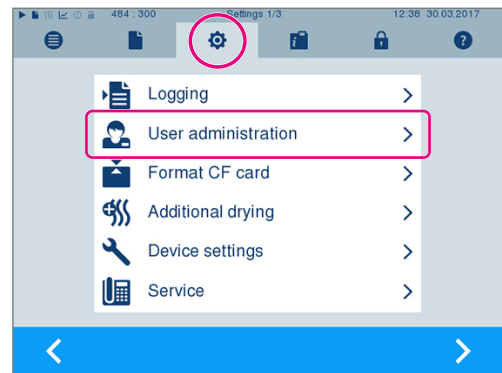

2. Entry of the Admin PIN is necessary to reach the **User administration** menu and undertake settings. Enter the Admin PIN (standard 1000) and confirm with LOGIN.

➡ The display switches to **User administration** window.

3. Select menu **User list** to display the user list.

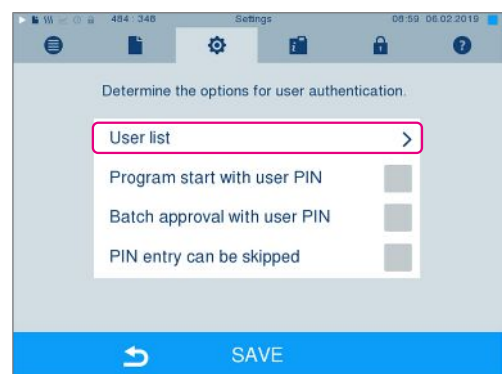

- Select a free ID and select EDIT. in order to create a new user. The first ID is reserved for the Admin PIN.



- Enter a 4-digit PIN in the right-hand key pad for the selected user ID.

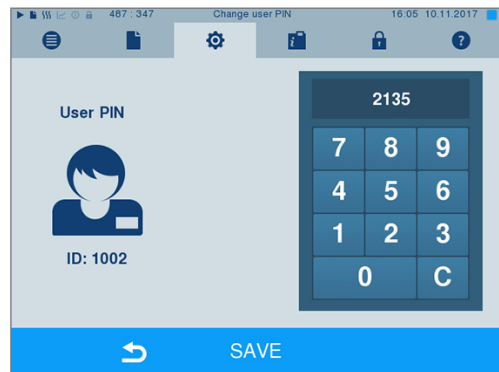

- Press SAVE to accept all settings and leave the menu.

Deleting a user

- Select the **User administration** option as described above and open the user list.



- Select the user ID that you wish to delete.

- Press  to delete this user.

↳ A warning is issued.

- Confirm the warning with YES.

↳ The PIN number of this ID is set to "0".

↳ A new PIN can be issued for this user ID at any time.

Changing the Admin PIN

PLEASE NOTE

If you forget the Admin PIN, consult your stockist/MELAG customer services provider.

The Admin PIN (standard: 1000) can be edited like every other user PIN and should be changed after delivery.

User authentication for sterilization

The user authentication can be set to ensure exact logging and verification. User authentication is performed by entry of the user PIN. The following settings are possible:

- Query user authentication upon program start
- Query user authentication upon program end
- Query user authentication upon program start and end
- You can skip the query user authentication

Determining options for the user authentication

1. Select the **Settings > User administration** menu.

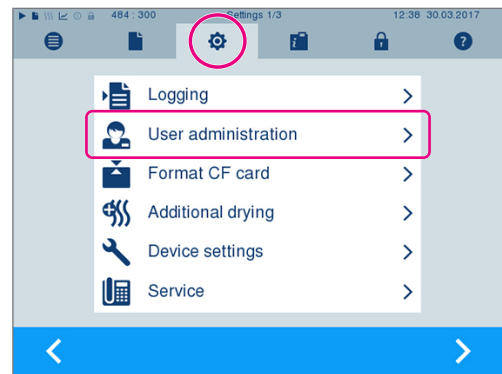

2. Entry of the Admin PIN is necessary to reach the **User administration** menu and undertake settings. Enter the Admin PIN (standard 1000) and confirm with LOGIN.

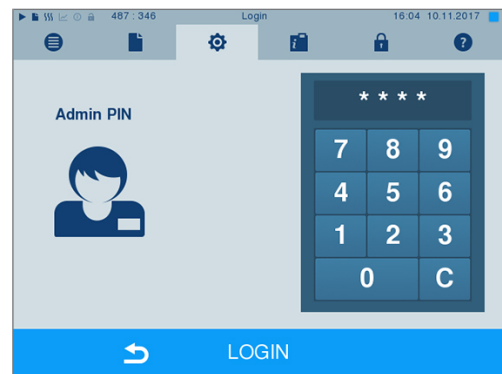

↳ The display switches to **User administration** window.

3. Set a checkmark next to **Program start with user PIN** to perform user authentication upon every program start. The program will start only after entry of the user PIN.

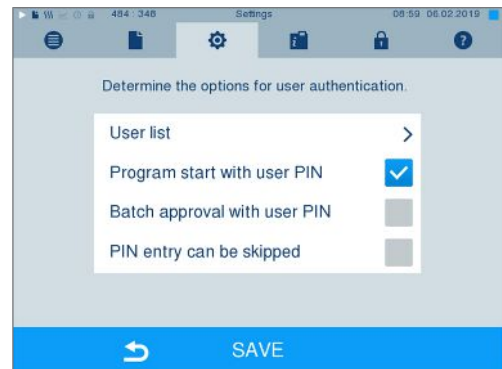

- Set a checkmark next to **Batch approval with user PIN** to perform user authentication upon every program end. The device door will open following program end only after the user PIN has been entered.

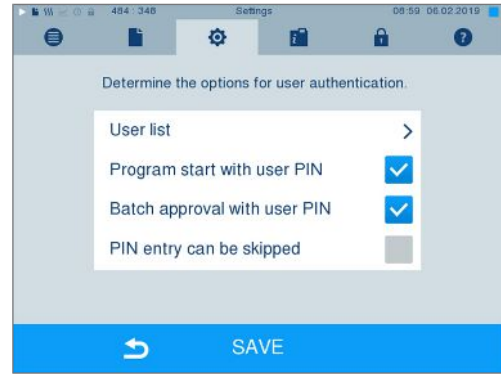

- Set a checkmark next to **PIN entry can be skipped** to enable the user PIN query to be skipped.

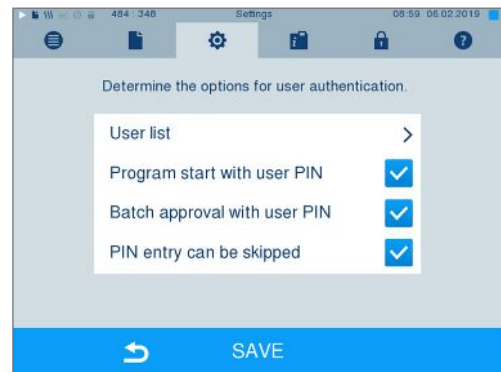

→ The user PIN query continues to be displayed before program start or after program end. Press  to skip user authentication.

- Press **SAVE** to accept all settings and leave the menu.

Formatting the CF card

NOTICE

Warning of data loss

All data stored on the CF card is deleted during formatting.

- Check whether important data is stored on the CF card.
- Save any logs or other data on the computer or another memory medium.

- Insert the CF card in the steam sterilizer card slot correctly (tangible raised bar on the edge pointing back right). Do not use force.
- Select the **Settings > Format CF card** menu.
- To start formatting, press the **OK** button.

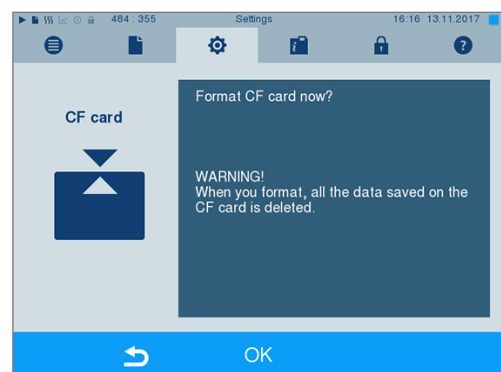

- Confirm the security query with YES. You can remove the CF card as soon as formatting has been completed.

Additional drying

Selecting additional drying extends the drying time of conventional drying by 50 %. Activating intelligent drying restricts the criteria for ending the drying phase.

Activating/deactivating additional drying for all program runs

- Select the **Settings > Additional drying** menu.

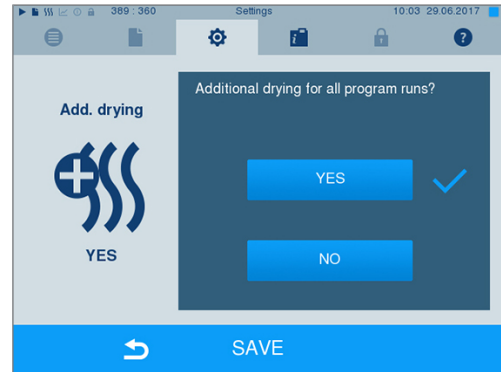

- Press YES or NO to set whether additional drying should be performed during all subsequent program runs.
- Confirm with SAVE.

Activating/deactivating additional drying for the current program run

You can activate or deactivate additional drying exclusively for the current program during the program run and into the sterilization phase. The settings during the program run are not carried over for the subsequent program runs.

- Select the desired program.
- Press START.
- Select the **Settings** menu.

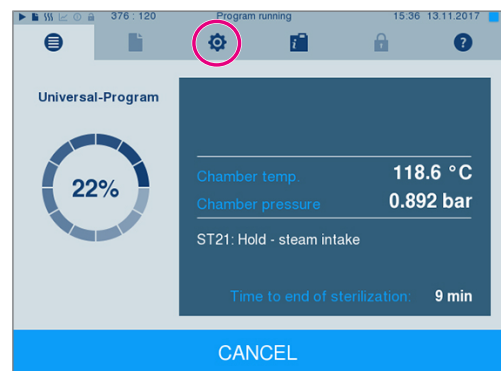

- Check or uncheck the option **Additional drying**.

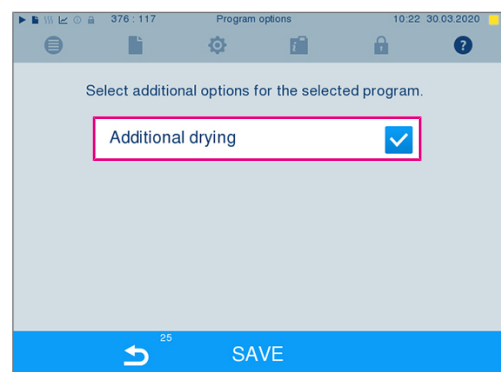

5. Press SAVE to accept all settings and leave the menu.

Intelligent drying

In contrast to a conventional time-controlled drying procedure, in which the duration of the drying phase is determined by the program, the duration of the intelligent drying is automatically calculated using the residual moisture in the sterilization chamber. A number of factors play a role in this process including the type of load, whether it is wrapped or unwrapped, the load quantity, and the distribution of the load in the sterilization chamber, see [Loading the steam sterilizer](#) [▶ page 22].

Intelligent drying is activated in the delivery state. Should you wish to deactivate intelligent drying, proceed as follows:

1. Select the **Settings > Device settings > Intelligent drying** menu. The display switches to the corresponding window.
2. If you wish to deactivate intelligent drying, select NO.

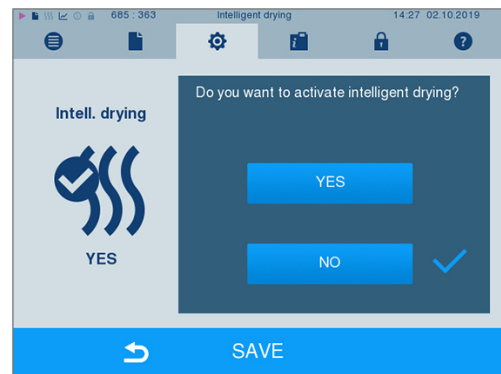

3. Press SAVE to accept all settings and leave the menu.

Water supply

According to whether the [feed water](#) supply comes from the internal storage tank or you have made the connection to a water treatment unit, proceed as follows:

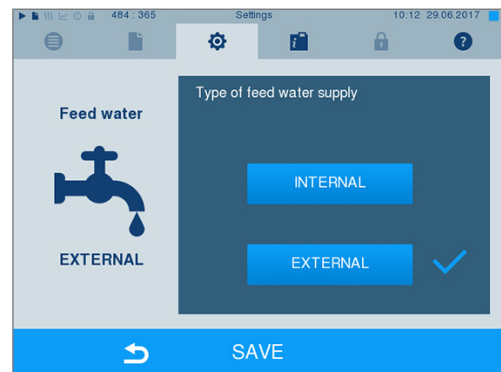

1. Select the **Settings** menu.
2. Navigate to **Device settings > Water supply**.
 ↳ The display switches to **Water supply** window.
3. Select INTERNAL, if the supply is to be performed via the internal storage tank or EXTERNAL, if you have connected a water treatment unit. **NOTICE! With an external supply, an external disposal system must be connected, otherwise hot water could run through the emergency release.**





4. Press SAVE to accept all settings and leave the menu.

Date and time

Correct ▶batch documentation requires the correct date and time setting on the device. Ensure that you take into account the clock change in autumn and summer, as this is not adjusted automatically. Set the date and time as follows:

1. Select the **Settings > Date & time** menu.
2. Select the parameters which you wish to change (day, month, year / hour, minute).
 - ↳ The marked parameter is depicted light blue, here e.g. the day.
3. Change the respective value using  and . Repeat this step for all the parameters which you wish to change.
4. Press SAVE to accept all settings and leave the menu.
 - ↳ The display is restarted.

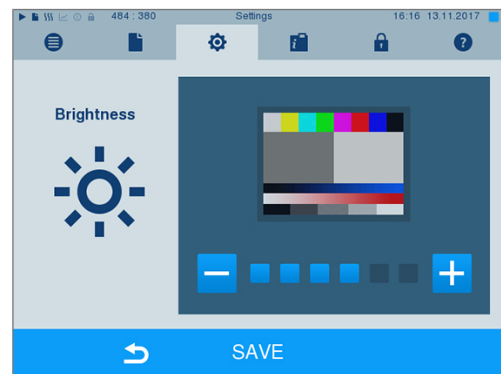

Brightness

1. Select the **Settings > Brightness** menu.
2. Press  or  to adjust the brightness and contrast on the display.



3. Press SAVE to accept all settings and leave the menu.

Volume

1. Select the **Settings > Volume** menu.
2. Press  or  to adjust the volume.

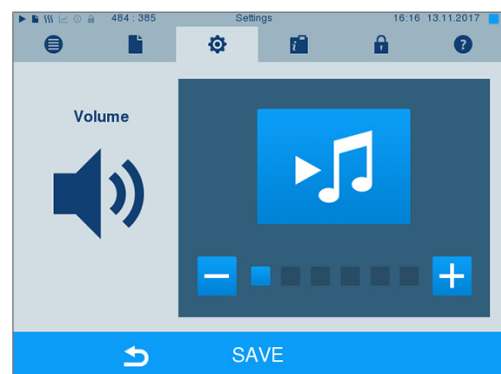

3. Press SAVE to accept all settings and leave the menu.

View

You can choose between classic and modern view.

Switching from MODERN to CLASSIC

1. Select the **Settings > View** menu. The display switches to the settings window.

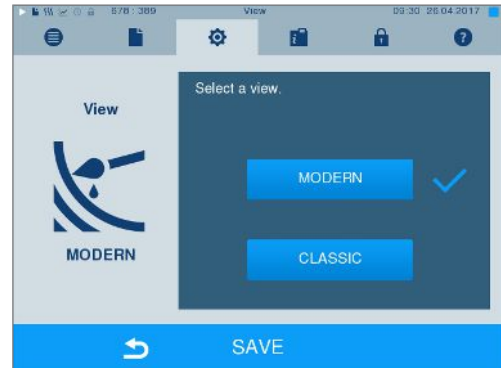

2. Press the CLASSIC button. The design changes immediately.

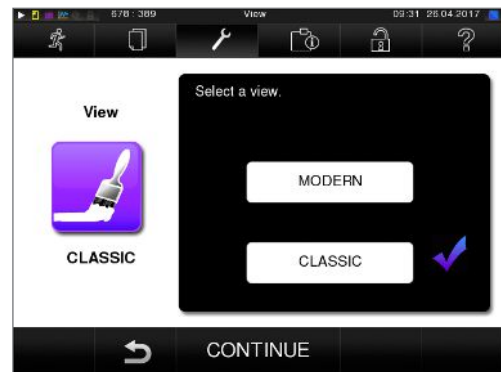

3. Press CONTINUE.
4. Tap on a colour box to change the background colour. The white frame around the colour box indicates which colour is currently selected.
 - ↳ The background colour changes immediately.
5. Press SAVE to accept all settings and leave the menu.

Switching from CLASSIC to MODERN

1. Select the **Settings > View** menu.



2. Press the MODERN button.
 - ↳ The design changes immediately.
3. Press SAVE to accept all settings and leave the menu.

Key tone

1. Select the **Settings > Key tone** menu.
2. Press YES or NO to set whether a tone should be emitted every time a pushbutton is pressed. This can be deactivated at any time.

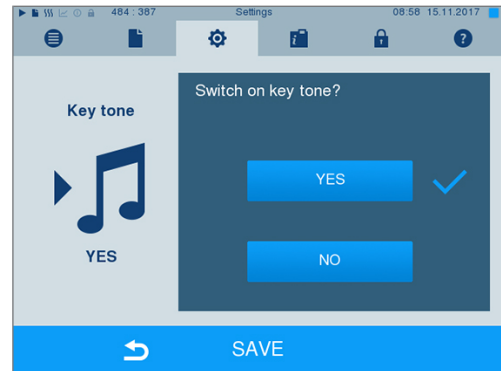

3. Press SAVE to accept all settings and leave the menu.

Screensaver

A screensaver can be activated to protect the display in standby operation. This displays a continuous slide show of any pictures.

Select images for the slide show

1. Select the **Settings > Screensaver** menu.

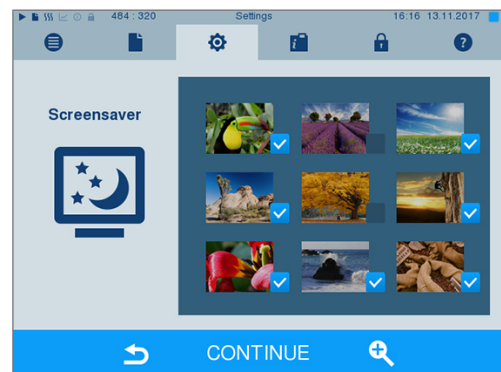



2. Tap on a picture to select it. The white frame around the picture indicates which picture is currently selected.
3. Repeated tapping on the picture selects/deselects it for the slide show.
 - ↳ The checkmark on the lower right-hand corner indicates whether the picture has been selected for the slide show.
4. Press CONTINUE to make further settings.

Setting the display duration of the pictures and the waiting time of the slide show

Proceed as follows to alter one of the named options:

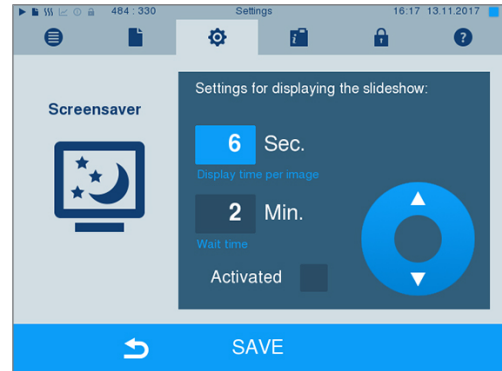
1. Select the parameter directly that you wish to change. The marked parameters are displayed light blue.



2. Change the respective parameter value via the  and  pushbuttons.
3. Press SAVE to accept all settings and leave the menu.

Explanation of the slide show options

Display duration per picture	Indicates the time in seconds between the display of two separate pictures.
Waiting time	Indicates how long the display remains in normal mode before the slide show starts.
Activated	Setting/unsetting the checkmark activates/deactivates the screensaver.



Log printer MELAprint 42/44

If you wish to output the sterilization log via the log printer MELAprint 42/44, you need to set this on the steam sterilizer once. The user manual of the log printer indicates how to set it up.

MELAprint 60 label printer

If you wish to output the sterilization log via the MELAprint 60 label printer, you need to set this on the steam sterilizer once. The user manual of the label printer indicates how to set it up.

Sensitivity

1. Select the **Settings > Touchscreen sensitivity** menu.
2. Press  or  to adjust how much pressure must be applied when touching a button to trigger an event.

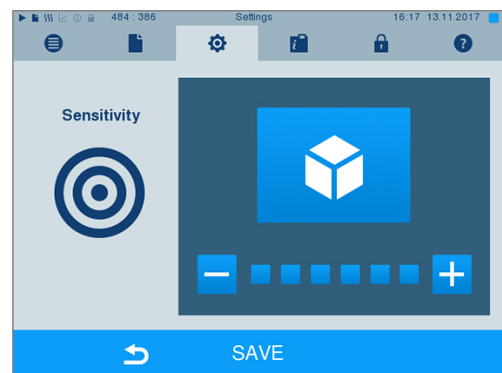

3. Press SAVE to accept all settings and leave the menu.



Energy-saving mode

If the steam sterilizer is not to be switched off during longer operating pauses, it can be operated in energy-saving mode. This reduces the time that is required in order to pre-heat the ▶double jacket steam generator to the necessary start temperature after deactivation. Two waiting times can be set in energy-saving mode:

Waiting time 1 (W1): After a pre-set waiting time of 15 min, the temperature of the ▶double jacket steam generator falls to 103 °C. The program run time increases by approx. 2 min upon the next start.

Waiting time 2 (W2): After a pre-set waiting time of 60 min, the ▶double jacket steam generator is no longer heated. Accordingly, the length of the program run time increases by approx. 5 min upon the next start, depending on the length of the operating pause, as the double jacket steam generator must first be pre-heated to the necessary start temperature.

In order to set up the energy saving mode, proceed as follows:

1. Select the **Settings > Energy saving mode** menu.
2. Select waiting time 1 directly by touching.
 - ↳ The area is displayed light blue.
3. Press  or  to adjust the minutes.
4. Repeat the step for waiting time 2.
5. Press CONTINUE.

Switching off the display

You can choose whether the display is to be switched off when the steam sterilizer is in energy-saving mode (waiting time 2).

1. Set the check-mark next to **Activated**, and set the number of seconds after which the display is to be deactivated.

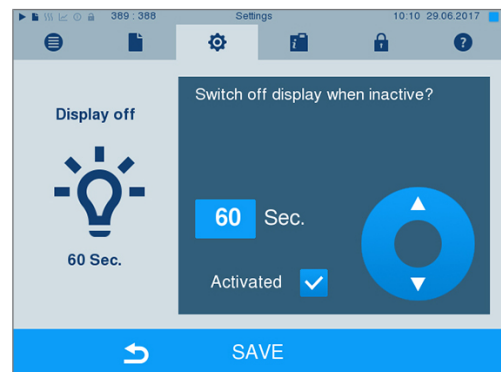

2. Press SAVE to accept all settings and leave the menu.
3. Switch the display back on by touching the screen.

11 Maintenance

Servicing intervals

Interval	Measure	Device component
Daily	Check for soiling, deposits or damage	Sterilization chamber including door gasket and chamber seal face, door lock, mount for the load
Weekly	Cleaning	Sterilization chamber including door gasket and chamber seal face, door lock, mount for the load
With every filling of the storage tank	Check the storage tank for soiling and clean it if necessary before filling	Internal storage tank
Every 2 weeks	Clean the left-hand chamber of the storage tank (wastewater)	Internal storage tank
Every 2 months	Clean, check and oil the locking spindle and nut	Door mechanism
After 24 months or 2000 cycles	Maintenance	by the authorised customer services working in accordance with the maintenance instructions
As required	Clean the surfaces	Housing parts

Cleaning

NOTICE

Warning of material damage from incorrect cleaning

Inappropriately performed cleaning can lead to the scratching of and damage to surfaces as well as the development of leaks in sealing faces. This also favours the development of soiling deposits and [corrosion](#) in the [sterilization chamber](#).

- Comply with all information regarding cleaning of the parts affected.
- Do not use any hard objects for cleaning such as a metal saucepan cleaner or a wire brush.

Sterilization chamber, door gasket, mount, trays

To maintain the value of your device and to avoid persistent contamination and deposits, MELAG recommends weekly cleaning of the surfaces. Use the Chamber Protect chamber cleaning set or, if not available, a neutral liquid cleaner or spirit.

PLEASE NOTE: Note the instructions for use of the cleaning agent.

The following must be fulfilled or present:

- ✓ Chamber Protect (if not available: neutral liquid cleaner or spirits)
- ✓ The door is open.
- ✓ The device is switched off and has cooled down completely.
- ✓ Trays or sterile containers and the associated mount have been removed from the sterilization chamber.

1. Apply the cleaning agent on a lint-free cloth.
2. Use a lint-free cloth to uniformly spread the cleaning agent on the surfaces to be cleaned.

PLEASE NOTE: Do not allow cleaning agents to get into the pipes coming from the sterilization chamber.

3. Allow the cleaning fluid to act and evaporate for a sufficient time. This may take a few minutes.
4. Wet a new lint-free cloth with plenty of demineralised water.
5. **NOTICE! Warning of material damage.** Residues of cleaning fluids can ignite or cause deposits on the instruments. Wipe the cleaned surfaces thoroughly. If necessary, wring out the cloth and repeat the process.
6. Allow the cleaned surfaces to dry completely. This may take a few minutes.

- 7. Wipe the cleaned surfaces with a dry, lint-free microfibre cloth.

Housing parts

Where necessary, clean the housing parts with a neutral fluid cleaner or spirit.

Comply with the following specifications when disinfecting the housing parts:

- Use wipe disinfectants and not spray disinfectants. This prevents disinfectant from getting into inaccessible places or ventilation slots.
- Only use alcohol-based surface disinfectants (ethanol or isopropanol) or alcohol-free disinfectants based on quaternary ammonium compounds.
- Do not use disinfectants containing secondary and tertiary alkylamines or butanone.

Internal storage tank

Should you use the internal storage tank for the feed water supply, perform regular checks and cleaning as follows:

Interval	Measure
Upon every refill	Check the storage tank for soiling. If necessary, clean the storage tank with fresh feed water before filling.
Every 2 weeks	Clean the left-hand side chamber of the storage tank (wastewater).

Video tutorial

See also "Filling and emptying stand-alone autoclaves" (<https://www.melag.com/en/service/tutorial/autoclave>).



⚠ CAUTION

Hot wastewater in the storage tank and at the water drain tap.

This could result in burns

- Empty the storage tank before cleaning.
- Do not touch the water drain tap and parts connected to it with unprotected hands.

Empty the chamber of the internal storage tank

1. Open the service hatch in the lower area of the steam sterilizer.

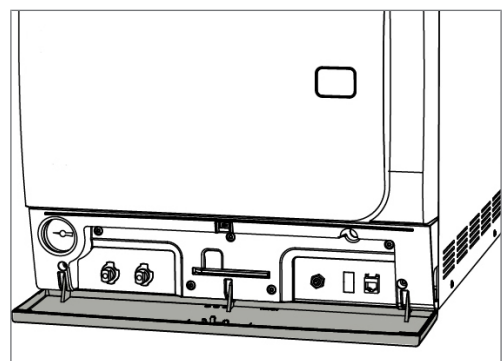

2. Place a min. 5 l bucket in front of the steam sterilizer.

3. Connect the drain hose onto one of the drain valves on the wastewater side (pos. a) or the feed water side (pos. b) until it snaps into place. The knob must be vertical.

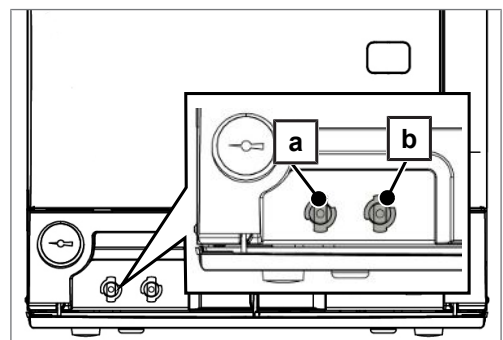

4. Open the water drain tap by turning the knob 1/4 in an anti-clockwise direction.

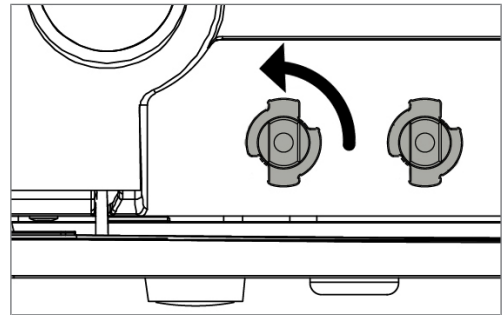

5. To remove the drain hose, turn the hose connection into the vertical position.

Cleaning the feed and wastewater side

You can remove the cover of the storage tank completely to clean the chambers of the internal storage tank.

1. Remove the fore tank lid.
2. Grasp the cover on the filling opening and then lift the cover upwards a little.

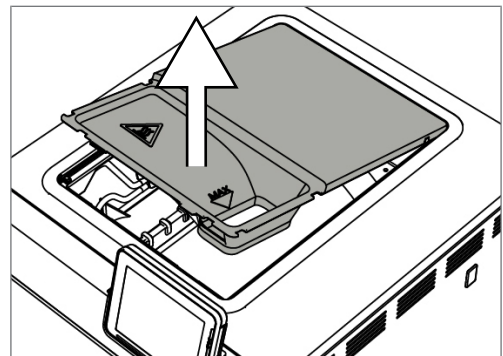

3. Then remove the cover from the rubber seal completely.

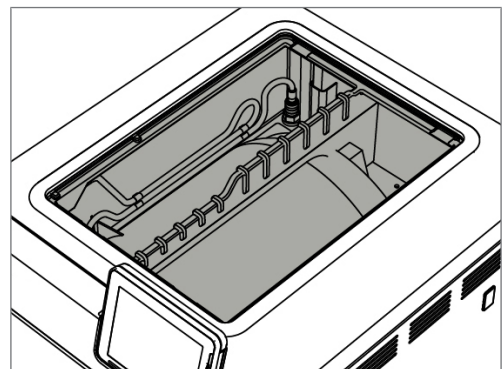

Avoiding staining

Only proper cleaning of the instruments prior to sterilization enables you to avoid residue from being released from the load under steam pressure during sterilization. Loosened dirt residue can clog the filter, fittings and valves of the device and deposit themselves on the instruments and in the sterilization chamber as deposits and stains.

All steam-conducting parts of the device consist of non-rusting material. This rules out the development of rust caused by the device. Any rust which develops is always extraneous rust.

Incorrect instrument reprocessing can result in the accretion of rust even on stainless steel instruments of leading manufacturers. Often, a single instrument which drops rust can suffice to cause the development of rust on other instruments or in the device. Remove foreign rust from the instruments using chlorine-free stainless steel cleaning fluid (see [Cleaning](#) [▶ page 60]) or send the damaged instruments to the manufacturer.

The extent of stain accretion on the instruments is also dependant on the [▶feed water](#) used for steam generation.

Replacing of the door gasket

Replace a worn, porous or cracked door gasket immediately:

1. Remove the door gasket from the groove in the round door.
2. Insert the new door gasket into the groove at four points that are evenly distributed over the door rim.
3. Press the gasket into the groove in each of the four quadrants. Ensure even distribution.

Checking and oiling the door lock

NOTICE

Warning of material damage from wear

If the door lock is not oiled regularly it can become worn. Pressure-tight closing of the door can no longer be ensured.

- Check and oil the door lock every two months.
- Use MELAG oil (included in the scope of delivery) to oil the door lock.

Check and oil the door lock every two months as follows:

1. Clean the locking spindle and nut with a non-fuzzing cloth.
2. Insert the test gauge into the door lock nut as far as it will go and turn it 180°. If this is not possible or resistance can be felt, the door lock nut is worn. Have the door lock nut replaced by an authorised technician.
3. Put two drops of oil in the door lock nut.
 - ➔ The oil will be distributed automatically by closing the door.



Replacing the sterile filter

Comply with the following for safe handling:

- The sterile filter is no longer effective if it has become wet. Stop using the sterile filter and replace it.
 - Do not replace the sterile filter during a program run.
1. Unscrew the sterile filter counter-clockwise from the holding socket.
 2. Replace the sterile filter with a new sterile filter.
 3. Turn the new sterile filter clockwise straight into the holding socket.

Maintenance

Comply with the following for safe handling:

- Maintain the specified maintenance intervals. Continuing operation beyond the maintenance interval can result in malfunctions in the device.
- Have maintenance performed only by trained and authorised technicians using the original MELAG maintenance set.
- If components that are not included in the maintenance set have to be replaced during maintenance, only original spare parts from MELAG may be used for the replacement.

Regular maintenance is vital to ensure reliable operation and value retention of the device. All function and safety-relevant components and electrical units must be checked during maintenance and replaced where necessary.

Maintenance must be carried out regularly after 2000 cycles, however, after 24 months at the latest. The steam sterilizer will issue a maintenance message at the relevant time.

12 Pause times

Frequency of sterilization

Pause times between the individual programs are not necessary, as the sterilization chamber is maintained permanently at the same temperature. After the end/abort of the drying time and removal of the [sterile material](#), you can load the steam sterilizer again and start a new program.

Duration of the operating pause

Duration of the operating pause	Measure
Short pauses between two sterilization processes	<ul style="list-style-type: none"> • Keep the door closed to save energy • Set the energy-saving mode correspondingly
Pauses which last longer than an hour	<ul style="list-style-type: none"> • Switch off the steam sterilizer
Longer pauses e.g. over night or the weekend	<ul style="list-style-type: none"> • Open the door and switch off the steam sterilizer • Leave the door ajar to prevent premature wear and the sticking of the door gasket • If present, shut off the water inflow of the water treatment unit
Longer than two weeks	<p>Before starting the operating pause:</p> <ul style="list-style-type: none"> • Open the door and switch off the steam sterilizer • Leave the door ajar to prevent premature wear and the sticking of the door gasket • If present, shut off the water inflow of the water treatment unit • Empty the internal storage tank <p>Following the operating pause:</p> <ul style="list-style-type: none"> • Fill the internal feed water tank • Perform a vacuum test • After a successful vacuum test, perform an empty sterilization run in Quick-Program S

After pauses, perform the checks described in chapter [Function checks](#) [▶ page 41] depending on the length of pause.

Decommissioning

When decommissioning the device for a long pause (e.g. due to holiday), proceed as follows:

1. Empty the double jacket steam generator, see [Emptying the double jacket](#) [▶ page 64].
2. Switch off the steam sterilizer at the power switch.
3. Disconnect the power plug from the socket and if necessary, allow the device to cool.
4. Empty the internal storage tank via the drain hose.
5. Shut off if present, the water inflow of the water treatment unit.

Emptying the double jacket

You have the option of draining the water in the double jacket steam generator easily via program Drain. In order to do so, the steam sterilizer is heated once, building up pressure in the double jacket so that the water can be drained fully from the double jacket steam generator.

1. Switch on the steam sterilizer at the power switch.

- Working in menu **Programs & Tests** select program **Drain** and press **START**.

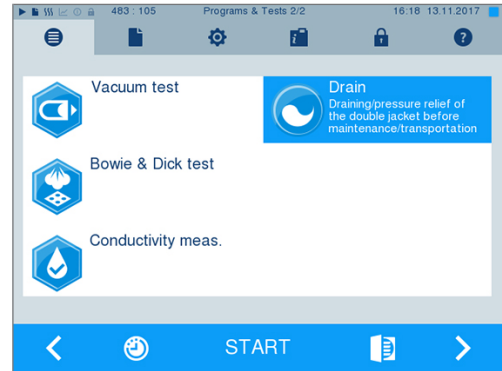

- Following notification **Draining successful** switch off the steam sterilizer, so that water is not fed into the double jacket.

Transport

⚠ CAUTION

Warning of injury

Lifting and carrying the device incorrectly can cause spinal damage, crushing injuries and bruising.

- Carry the device with at least two people.
- Use the correct carrying straps to carry the device.
- Comply with the safety regulations that apply to you.

Comply with the following for safe handling:

- Store and transport the device frost-free.
- Avoid strong shocks/vibrations.
- Store the device in a fashion protected against moisture.

Transport within the practice

Comply with the following provisions during transport within a room or the practice:

- Should you wish to leave the mount and trays or containers in the sterilization chamber during transport, protect the surface of the round blank. To do so, place e.g. some foam or bubble wrap between the round blank and mount.
- Close the door of the steam sterilizer.
- Decommission the steam sterilizer, see [Decommissioning](#) [▶ page 64].
- Disconnect the connection hoses connected on the rear of the device.

Transport over long-distance / dispatch

For transport over longer distances, during the danger of frost and / for despatch or during maintenance, an [authorized person](#) must prepare the steam sterilizer according to instructions and empty the [double-jacket steam generator](#) entirely.

Recommissioning after relocation



When recommissioning after changing the location of the device, proceed as for initial commissioning, see Technical manual.

13 Malfunctions

Comply with the following for safe handling:

- Should the device issue the same malfunction message repeatedly, turn off the device and if necessary, inform your stockist.
- The device may only be serviced by ► [authorised technicians](#).

Not all notifications on the display are malfunction messages. Warnings and malfunction messages are issued on the display with an event number. This number serves identification purposes.

	Type of message	Description
	Notification	A number of notifications are messages providing information. They support the operation of the steam sterilizer.
	Warning message	Warnings are displayed when necessary. These contain instructions that apply to you, the operator. Warning messages are not malfunction messages. They help to ensure malfunction-free operation and to recognise undesirable situations. Comply with these warnings early in order to prevent malfunctions.
	Malfunction message	Malfunction messages are issued when it is not possible to ensure safe operation or safety of sterilization. These can appear on the display shortly after activating the steam sterilizer or during a program run. If a malfunction occurs during a program run, the program will be aborted.

Troubleshooting online

All messages with current descriptions can be found in the Troubleshooting portal on the MELAG website (<https://www.melag.com/en/service/troubleshooting>).



Before contacting the technical service

Follow the instructions that appear on the device's display that relate to a warning or malfunction message. The following table contains a summary of the most important events. Should you be unable to find the relevant event, or your efforts do not redress the problem, you can contact your stockist or the MELAG customer service. Have the number of your device, the event number and a detailed description of the malfunction to hand so that we can help you.

Messages

Event	Possible causes	What you can do
248	Vacuum test was carried out despite residual moisture in the sterilization chamber or with a load.	Repeat vacuum test if steam sterilizer is cold and empty.

Warning and error messages

Event	Possible causes	What you can do
62	When using the internal storage tank: a) Insufficient feed water in the right-hand chamber of the internal storage tank. b) The float switch in the right-hand chamber of the internal storage tank (feed water) is stuck.	a) Check whether sufficient feed water is in the right-hand chamber of the internal storage tank and refill with feed water if necessary. b) Check the float switch as follows: 1. Remove the tank lid from the storage tank. 2. Remove the filling funnel if present. 3. Move the float in the right-hand chamber of the storage tank (feed water side from below in the tank) up and down repeatedly to restore its free-movement.
	When using a MELAG water treatment unit: c) The feed water supply is set to INTERNAL in the device.	When using a MELAG water treatment unit: c) Set the feed water supply in the Settings menu to EXTERNAL , see Water supply ► page 54].

Event	Possible causes	What you can do
63	The quality of the feed water is very poor (conductivity $\geq 60 \mu\text{S/cm}$).	
	When using the internal storage tank: a) Water of insufficient quality, e.g. tap water, was used. When using a MELAG water treatment unit: b) MELAdem 40: The mixed-bed resin cartridge is exhausted. c) MELAdem 47: The mixed-bed resin cartridge, the pre-filter or the activated coal filter is exhausted.	a) Empty and clean the right-hand chamber of the internal storage tank (feed water side) and fill it with water of the required quality (EN 13060). b) MELAdem 40: Replace the mixed-bed resin cartridge in accordance with the applicable user manual. c) MELAdem 47: Please replace the mixed-bed resin cartridge and if necessary, the pre-filter and the activated carbon filter in accordance with the applicable user manual. Empty the pressure tank (if possible until it is half full) and wait until it has been filled again. An empty pressure tank requires approx. 1 h to fill. PLEASE NOTE: The message may also continue to be shown after the filter has been replaced until the water remaining in the storage tank has been consumed.
64	see event 63	
65	see event 63	
66	The feed water inflow line between the water treatment unit and the steam sterilizer is leaking. Air is also drawn in.	When using a MELAG water treatment unit: Check whether the feed water inflow line to the steam sterilizer has any leaks and has been connected correctly.
67	Only when using a water treatment unit: The wastewater cannot flow off. However, a rinse must be carried out after a further 2 to 3 programs. a) The outlet hose is kinked or sags. b) The siphon or the building-side outlet line is blocked. c) Quick-Program B and Quick-Program S are mainly used. These programs do not have automatic rinsing.	a) Check the installation of the outlet hose. It must be installed without kinking or sagging and at a constant decline. b) Check whether the building siphon is blocked. PLEASE NOTE: If multiple devices are operated simultaneously, MELAG recommends the installation of an additional siphon. c) Start another program e.g. Universal-Program, Gentle-Program or Prion-Program to perform the necessary rinsing.
71	When using the internal storage tank: a) Insufficient feed water in the right-hand chamber of the internal storage tank. b) The float switch of the right-hand chamber of the internal storage tank (feed water) is stuck.	When using the internal storage tank: a) Check the water level of the feed water in the right-hand chamber of the internal storage tank and refill with feed water if necessary. b) Check the float switch as follows: 1. Remove the tank lid from the storage tank. 2. Remove the filling funnel if present. 3. Move the float in the right-hand chamber of the storage tank (feed water side from below in the tank) up and down repeatedly to restore its free-movement.
	When using a MELAG water treatment unit: c) The water supply is set to INTERNAL despite external water supply.	When using a MELAG water treatment unit: c) Set the feed water supply in the Settings menu to EXTERNAL , see Water supply [▶ page 54].

Event	Possible causes	What you can do
72	<p>Poor feed water quality (conductivity $\geq 40 \mu\text{S/cm}$).</p> <p>When using the internal storage tank: a) Water of insufficient quality, e.g. tap water, was used.</p> <p>When using a MELAG water treatment unit: b) MELAdem 40: The mixed-bed resin cartridge is exhausted. c) MELAdem 47: The mixed-bed resin cartridge, the pre-filter or the activated coal filter is exhausted.</p>	<p>a) Empty and clean the right-hand chamber of the internal storage tank (feed water side) and fill it with water of the required quality (EN 13060).</p> <p>b) MELAdem 40: Replace the mixed-bed resin cartridge in accordance with the applicable user manual.</p> <p>c) MELAdem 47: Please replace the mixed-bed resin cartridge and if necessary, the pre-filter and the activated carbon filter in accordance with the applicable user manual. Empty the pressure tank (if possible until it is half full) and wait until it has been filled again. An empty pressure tank requires approx. 1 h to fill. PLEASE NOTE: The message may also continue to be shown after the filter has been replaced until the water remaining in the pressure tank has been consumed.</p>
73	see event 72	
74	<p>Poor feed water quality (conductivity $\geq 40 \mu\text{S/cm}$).</p> <p>When using the internal storage tank: a) Insufficient feed water in the right-hand chamber of the internal storage tank. b) The float switch of the right-hand chamber of the internal storage tank (feed water) is stuck.</p> <p>When using a MELAG water treatment unit: c) The water supply is set to INTERNAL despite external water supply.</p>	<p>a) Check the water level of the feed water in the right-hand chamber of the internal storage tank and refill with feed water if necessary. b) Check the float switch as follows: 1. Remove the tank lid from the storage tank. 2. Remove the filling funnel if present. 3. Move the float in the right-hand chamber of the storage tank (feed water side from below in the tank) up and down repeatedly to restore its free-movement.</p> <p>When using a MELAG water treatment unit: c) Set the feed water supply in the Settings menu to EXTERNAL, see Water supply [▶ page 54].</p>
75	<p>When using the internal storage tank: a) Insufficient feed water in the right-hand chamber of the internal storage tank. b) The float switch of the right-hand chamber of the internal storage tank (feed water) is stuck.</p> <p>When using a MELAG water treatment unit: c) The water supply is set to INTERNAL despite external water supply.</p>	<p>a) Check the water level of the feed water in the right-hand chamber of the internal storage tank and refill with feed water if necessary. b) Check the float switch as follows: 1. Remove the tank lid from the storage tank. 2. Remove the filling funnel if present. 3. Move the float in the right-hand chamber of the storage tank (feed water side from below in the tank) up and down repeatedly to restore its free-movement.</p> <p>When using a MELAG water treatment unit: c) Set the feed water supply in the Settings menu to EXTERNAL, see Water supply [▶ page 54].</p>
76	<p>a) Quick-Program B and S are mainly used. These programs do not perform automatic rinsing. With connection to the building wastewater outflow: The wastewater cannot flow off. However, a rinse must be carried out after a further 2 to 3 programs. b) The wastewater hose is kinked or sags. c) The siphon or the building-side outlet line is blocked.</p>	<p>a) Start another program e.g. Universal-Program, Gentle-Program or Prion-Program to perform the necessary rinsing. For connection to the on-site wastewater drain: b) Check the installation of the wastewater hose. It must be installed without kinking or sagging and at a constant decline. c) Check whether the building siphon is blocked. PLEASE NOTE: If multiple devices are operated simultaneously, we recommend the installation of an additional siphon.</p>

Event	Possible causes	What you can do
78	<p>a) The left-hand chamber of the internal storage tank (waste water) is full or was only incompletely emptied.</p> <p>b) If the notification is displayed despite an empty tank, the float switch is blocked.</p>	<p>a) Empty the left-hand chamber of the storage tank (waste water).</p> <p>b) Check the float switch as follows:</p> <ol style="list-style-type: none"> 1. Remove the tank lid from the storage tank. 2. Remove the filling funnel if present. 3. Move the float in the left-hand chamber of the storage tank (feed water side from below in the tank) up and down repeatedly to restore its free-movement.
80	see event 78	
81	<p>a) The door was not pushed closed for long enough with sufficient force; as a result, the thread has become caught.</p> <p>b) The door spindle and/or the door lock nut were not properly maintained.</p> <p>c) The door spindle and/or the door lock nut were not oiled regularly and are dry.</p>	<p>a) Close and hold the door with force for approx. 3 s until the spindle engages in the door lock and the door is pulled in automatically. A motor sound is audible.</p> <p>b) Check the door lock every two months, see Checking and oiling the door lock [▶ page 63].</p> <p>c) Oil the door lock nut regularly with the MELAG oil, see Checking and oiling the door lock [▶ page 63].</p> <p>If this occurs repeatedly, please contact the technical service.</p>
82	<p>a) There are objects in the door area. The door was blocked from outside during the opening process.</p> <p>b) A residual vacuum is present in the sterilization chamber. Pressure equalisation has not been concluded.</p> <p>c) The door gasket sticks to the seal face of the sterilization chamber.</p>	<p>a) Always keep the area in front of the door free so that it can open unhindered.</p> <p>b) 1. Wait 2 min, and then acknowledge the message with OK.</p> <p>2. If the door does not open independently, switch off the steam sterilizer, wait 5 min, and then switch it back on. Try again to open the door.</p> <p>If the door does not open, inform the authorised technician.</p> <p>c) If it has proven possible to open the door (e.g. using the manual door emergency opening, see Manual door emergency opening [▶ page 19]) clean the door gasket and the seal face on the sterilization chamber, see Cleaning [▶ page 60].</p>
83	<p>The door does not reach a pressure-tight state after the program start.</p> <p>a) The door gasket and/or the seal face is soiled and or damaged.</p> <p>b) The load blocks the door area.</p> <p>c) The closing mechanism is stiff.</p>	<p>a) Check the door gasket and the seal face in the sterilization chamber for soiling, foreign bodies or damage.</p> <p>b) Check whether the load is blocking the door.</p> <p>c) Check the door spindle and the door lock nut for damage. Clean and oil the door spindle and the door lock nut with the oil included in the scope of delivery. Clean and oil the door spindle and the door lock nut with the oil included in the scope of delivery, see Checking and oiling the door lock [▶ page 63].</p>
84	see event 82	
86	The door has not been closed correctly upon program start.	Push the door with force for approx. 3 s until the spindle engages in the door lock nut and the door is closed automatically. A motor sound is audible.
89	see event 86	

Event	Possible causes	What you can do
102	a) The “pressure release” chamber filter is blocked.	a) Remove the “pressure release” chamber filter (in the rear area of the sterilization chamber, at the bottom) and check whether it is soiled/clogged, e.g. by packaging residues. If necessary, clean the chamber filter.
	With connection to the building wastewater outflow: The wastewater cannot flow off. b) The outlet hose is kinked or sags. c) The siphon or the building-side outlet line is blocked.	For connection to the on-site wastewater drain: b) Check the installation of outlet hose. It must be installed without kinking or sagging and at a constant decline. c) Check whether the building siphon is blocked. PLEASE NOTE: If multiple devices are operated simultaneously, MELAG recommends the installation of an additional siphon.
103	The sterile filter is soiled/blocked.	1. Check whether the sterile filter suction aperture (centre aperture) on the rear panel of the steam sterilizer is blocked. If yes, replace the sterile filter. 2. If nothing can be recognized, remove the sterile filter on the rear panel of the steam sterilizer and perform a program run without a load. If the program has been ended successfully, the sterile filter is blocked. In this case, replace the sterile filter.
104	see event 103	
110	a) The steam sterilizer is overloaded or the load has been arranged badly. b) The mains voltage is too low, poor building voltage supply (e.g. undersized installation, defective socket, multiple devices on a single socket/fuse).	a) Comply with the maximum permissible load quantities, see Loading the steam sterilizer [▶ page 21]. Ensure that the load does not come into direct contact with the steam injection nozzles or cover them. b) Check the on-site installation (e.g. automatic circuit breaker) or test the steam sterilizer at another socket or in another circuit.
111	see event 110	
113	a) The steam sterilizer was switched off at the power switch during a program run. b) The power plug has been disconnected or has not been connected correctly in the socket. c) Power outage in the building supply or the building-side RCD switch has tripped.	a) Never switch off the steam sterilizer at the power switch during a program run. b) Check whether the power plug is connected, the power cable has suffered damage or a loose contact or loose plug connections is the cause. Plug the power plug back into the mains socket. c) Arrange for an inspection of the building-side installation (e.g. automatic circuit breaker) and test the steam sterilizer at another socket or on another circuit.
114	see event 78	

Event	Possible causes	What you can do
124	<p>a) The surrounding temperature of the steam sterilizer is too hot.</p> <p>b) The minimum clearance to the surrounding surfaces has not been maintained. The steam sterilizer gets no or too little cooling air.</p> <p>c) The steam sterilizer is overloaded.</p> <p>d) The steam sterilizer was operated without a mount and the load (especially the textiles) come into direct contact with the chamber wall.</p> <p>e) The openings for drawing in the cooling air on the underside of the steam sterilizer are covered.</p> <p>f) The "vacuum" chamber filter is soiled/clogged.</p>	<p>a) The ambient temperature must be below 40 °C. We recommend a maximum temperature of 25 °C.</p> <p>b) Maintain a minimum clearance to the surrounding surfaces, see technical manual.</p> <p>c) Comply with the maximum permissible load quantities, see Selecting the program [▶ page 25]. If necessary, perform a vacuum test.</p> <p>d) Always operate the steam sterilizer with a mount and observe the instructions for loading, see Loading the steam sterilizer [▶ page 21].</p> <p>e) Check whether the openings for drawing in the cooling air on the underside of the steam sterilizer are covered and remove any objects in front of them, e.g. paper or packaging residues.</p> <p>f) Remove the "vacuum" chamber filter (in the rear area of the sterilization chamber) and check whether it is soiled/clogged, e.g. by packaging residues. If necessary, clean the chamber filter.</p>
125	see event 124	
126	see event 124	
127	see event 124	
131	see event 102	
132	The steam sterilizer is overloaded or the load has been arranged badly.	Comply with the maximum permissible load quantities, see Loading the steam sterilizer [▶ page 21]. Ensure that the load does not come into direct contact with or covers the steam injection nozzles.
133	see event 124	
136	<p>a) The surrounding temperature of the steam sterilizer is too hot.</p> <p>b) The ventilation slots in the side walls are clogged/blocked.</p> <p>c) The steam sterilizer is installed. The minimum clearance to the surrounding surfaces has not been maintained.</p> <p>d) The door was left open after loading or unloading and hot steam has escaped from the sterilization chamber.</p>	<p>Switch off the steam sterilizer and allow it to cool for approx. 1 h.</p> <p>a) Comply with the requirements at the installation location and the maximum ambient temperature, see Technical manual.</p> <p>b) Clean the ventilation slots and remove any objects covering them.</p> <p>c) Maintain a minimum clearance to the surrounding surfaces, see Technical manual.</p> <p>d) Always close the door after loading or unloading.</p>
175	The overheat protection switch of the main heating has tripped. This notification may be issued in alternation with E176: ACOUT 02 open .	<ol style="list-style-type: none"> 1. Switch off the steam sterilizer. Press in the overheat protection reset button on the fore side of the steam sterilizer (behind the panel) in. 2. Acknowledge the malfunction message. 3. Switch off the steam sterilizer and back on again and then perform an empty sterilization run if necessary. Steam sterilizer ready to operate. again
176	The overheat protection switch of the main heating has tripped. This message may be issued in alternation with E175: ACOUT 01 open .	<ol style="list-style-type: none"> 1. Switch off the steam sterilizer. Press in the overheat protection reset button on the fore side of the steam sterilizer (behind the panel) in. 2. Acknowledge the malfunction message. 3. Switch off the steam sterilizer and back on again and then perform an empty sterilization run if necessary. The steam sterilizer is now ready for operation.
182	The mains voltage is too low, poor building voltage supply (e.g. under-dimensioned building installation, defective socket, multiple devices connected to a single socket or fuse).	Arrange for an inspection of the building-side installation (e.g. automatic circuit breaker) and test the steam sterilizer at another socket or on another circuit.
183	see event 124	
185	see event 110	

Event	Possible causes	What you can do
186	see event 110	
187	a) The "pressure release" chamber filter is blocked.	a) Remove the "pressure release" chamber filter (in the rear area of the sterilization chamber, at the bottom) and check whether it is soiled/clogged, e.g. by packaging residues. If necessary, clean the chamber filter.
	With connection to the building wastewater outflow: The wastewater cannot flow off. b) The wastewater hose is kinked or sags. c) The siphon or the building-side outlet line is blocked.	For connection to the on-site wastewater drain: b) Check the installation of the wastewater hose. It must be installed without kinking or sagging and at a constant decline. c) Check whether the building siphon is blocked. PLEASE NOTE: If multiple devices are operated simultaneously, MELAG recommends the installation of an additional siphon.
192	When using the internal storage tank: a) The right-hand chamber of the internal storage tank (feed water) must be sufficiently filled with feed water for the pending rinsing process.	a) Check the water level of the feed water in the right-hand chamber of the internal storage tank and refill with feed water if necessary.
	When using a MELAG water treatment unit: b) A sufficient supply of feed water must be ensured for the pending rinsing process.	b) Check whether the water inflow tap for the water treatment unit is open. When using a MELAdem 47, also check whether the tap on the pressure tank is open.
193	The left-hand chamber of the internal storage tank (waste water) must be empty for the pending rinsing process.	NOTICE! Danger of draining through the emergency overflow. Check the water level and empty the left-hand chamber of the internal storage tank (wastewater) completely.
203	No options have been set for the output of logs.	Check the configuration in the Settings > Logging menu.
204	The internal log memory is full.	Output the log saved in the steam sterilizer on any output medium or adapt the general output options in the Settings > Logging menu.
207	see event 203	
208	see event 204	
211	see event 204	
214	The steam sterilizer has not recognised the CF card; it cannot be read, or it is damaged.	<ol style="list-style-type: none"> 1. Check whether the CF card has been inserted correctly (do not insert under voltage). 2. Make sure that the CF card is not larger than 4 GB. 3. Check whether the write-protection has been set on the CF card by mistake. 4. Test the CF card on a computer. 5. Check whether the memory on the CF is full. If the memory is full, transfer the log files on the CF card to a computer and delete the files on the CF card. 6. Transfer the log files on the CF card to a computer and re-format the CF card in the steam sterilizer. 7. The CF card is defective or incompatible. A non-MELAG CF card has possibly been used. PLEASE NOTE: MELAG recommends only using original MELAG CF cards.
218	The attempt was made to overwrite a write-protected log with a log of the same name.	<ol style="list-style-type: none"> 1. Transfer the log file the CF card to another computer and delete the file from the CF card. 2. Insert the empty CF card in the card slot and enter the log again.

Event	Possible causes	What you can do
221	The CF card or a subdirectory of the CF card is full.	1. Transfer the present log files from the CF card to a computer. 2. Format the CF card in the steam sterilizer. 3. Try again.
223	The CF card has not been recognized.	1. Transfer the present log files from the CF card to a computer. 2. Format the CF card in the steam sterilizer. 3. Try again.
224	see event 223	
228	see event 223	
229	The CF card was removed from the slot during a writing/reading action.	Never remove the CF card from the slot whilst it is being written or read. Insert the CF card in the card slot and repeat the procedure.
231	The CF card cannot be located/has not been inserted.	Check whether the CF card has been inserted correctly or insert it in the slot again. Upon repeated incidence, transfer the present log files from the CF card to a computer and format the CF card in the steam sterilizer and then try again.
232	see event 229	
236	File malfunction on the CF card.	1. Transfer the present log files from the CF card to a computer. 2. Format the CF card in the steam sterilizer. 3. Try again.
237	The CF card has not been recognised.	Check whether the CF card is write protected. Disable the write protection. Upon repeated incidence, transfer the present log files from the CF card to a computer and format the CF card in the steam sterilizer and then try again.
238	a) It is not possible to format the CF card because it is larger than 4 GB. b) The CF card is defective or incompatible. c) The CF card is write-protected.	a) Use only CF cards with a maximum storage capacity of 4 GB. b) 1. Try formatting the CF card on a computer. 2. The CF card is defective or incompatible. It is possible that a non-MELAG CF card has been used. PLEASE NOTE: MELAG recommends using only original MELAG CF cards. c) Disable the write-protection on the CF card.
240	The CF card has not been recognized.	Make sure that the CF card has been inserted in the slot correctly. Upon repeated incidence, transfer the present log files from the CF card to a computer and format the CF card in the steam sterilizer and then try again.
249	The door does not close. The door gasket and/or the seal face is soiled.	Check and clean the door gasket and seal face on the sterilization chamber for soiling, foreign bodies or damage, see Cleaning [▶ page 60].
305	a) The connection cable behind the display is loose or has a loose contact. b) The CF card is slow or defective.	a) Remove the display from the mount and check that the connection cable is correctly connected to the display and is undamaged. b) Use a different CF card.
351	The maximum operating interval or the number of batches since initial commissioning or the last maintenance have been reached. Maintenance is necessary.	Schedule a maintenance appointment with an authorised technician. You can continue to operate the steam sterilizer until the maintenance.
353	The steam sterilizer was switched off too early after alteration of the settings.	Always wait until the alterations in the steam sterilizer have been fully accepted before switching off the steam sterilizer. This is indicated in the display by changing into the previous menu or through the start screen.

Event	Possible causes	What you can do
367	The internal malfunction log memory is full.	Ensure that the selected output media are suitable for your instruments and are ready. Working in the Log output menu, output the non-outputted logs.
377	An attempt was made to output logs via the log printer but a log printer is not connected.	Check whether the log printer has been connected correctly. If you do not wish to output any logs in the log printer, deactivate the log printer as an output medium, see Logging [▶ page 43].
380	see event 377	
386	The internal program log memory is almost full.	Ensure that the selected output media are suitable for your instruments and are ready. Working in the Log output menu, output the non-outputted logs at the next opportunity.
397	<ul style="list-style-type: none"> a) The network cable has been disconnected or is damaged. b) The network cable is not compatible. c) The computer is not switched on. d) The network connection was not configured correctly. e) The documentation software on the computer was not started. 	<ul style="list-style-type: none"> a) Check whether the network cable has been connected correctly or is damaged. b) Check whether a 1:1 network cable has been connected. A 1:1 network cable must be used for the direct connection between steam sterilizer and computer. c) Switch on the computer. d) Check the network settings, see Logging [▶ page 43]. e) Start the documentation software.
402	<p>The door is blocked and cannot be closed.</p> <ul style="list-style-type: none"> a) The door gasket and/or the seal face is soiled and or damaged. b) The load blocks the door area. c) The closing mechanism is stiff. 	<ul style="list-style-type: none"> a) Check the door gasket and the seal face in the sterilization chamber for soiling, foreign bodies or damage. b) Check whether the load is blocking the door. c) Check the door spindle and the door lock nut for damage. Clean and oil the door spindle and the door lock nut with the oil included in the scope of delivery, see Checking and oiling the door lock [▶ page 63].
407	<p>The door does not reach a pressure-tight state after the program start.</p> <ul style="list-style-type: none"> a) The door gasket and/or the seal face is soiled and or damaged. b) The load blocks the door area. c) The closing mechanism is stiff. 	<ul style="list-style-type: none"> a) Check the door gasket and the seal face in the sterilization chamber for soiling, foreign bodies or damage. b) Check whether the load is blocking the door. c) Check the door spindle and the door lock nut for damage. Clean and oil the door spindle and the door lock nut with the oil included in the scope of delivery, see Checking and oiling the door lock [▶ page 63].
414	see event 102	
416	see event 214	
417	see event 397	
428	see event 102	
434	Overheat on temperature sensor 2	<ul style="list-style-type: none"> 1. Switch off the steam sterilizer and allow it to cool for 15 min. 2. Switch on the steam sterilizer. Steam sterilizer is ready to operate again. If this occurs repeatedly, please contact the technical service.
438	The steam sterilizer must be validated.	Arrange for validation of the steam sterilizer.
439	see event 187	
452	An attempt was made to execute actions on the display although the label printer is still printing labels.	Please wait until the label printer has printed all labels. The desired action can then be executed.
457	The date or time was set incorrectly.	Check the date and time settings and correct if necessary, see Date and time [▶ page 55].

Event	Possible causes	What you can do
458	a) The date or time was set incorrectly. b) The start time pre-selection timer has run down but the steam sterilizer was switched off at the time for which the start time was selected.	a) Check the date and time settings and correct if necessary, see Date and time [▶ page 55]. b) The steam sterilizer must be switched on at time for which the start time is selected.
464	An attempt was made to execute actions on the display although the log printer is still printing.	Please wait until the log printer has printed the log(s) completely. The desired action can then be executed.
465	a) The connection to the label printer has been interrupted. b) The label printer has not been switched on.	a) Check whether the power cable is connected to the socket and the Ethernet cable of the label printer is correctly connected with the steam sterilizer. b) Switch on the label printer. The power LED must illuminate green.
479	see event 397	
486	see event 82	
488	see event 457	
489	see event 136	
490	see event 136	
492	see event 136	
692	see event 132	
693	see event 132	
694	see event 132	

14 Technical data

Device type	Vacuklav 41 B+	Vacuklav 43 B+
Device dimensions (H x W x D)	56.5 x 46 x 58 cm	56.5 x 46 x 69 cm
Empty weight	60 kg	64 kg
Operating weight	81 kg	91 kg
Pressure vessel		
permitted working pressure (relative)	3.5 bar	
permitted working temperature	150°C	
Sterilization chamber		
Diameter	25 cm	
Depth	35 cm	45 cm
Volume	18.4 l	23.8 l
Electrical connection		
Electrical power	3400 W 2800 W ^{*)}	
Power supply	220-240 V, 50/60 Hz	
Max. voltage range	207-253 V	
Building fuse	16 A, residual current device (RCD) 30 mA for 3400 W 13 A, residual current device (RCD) 30 mA for 2800 W ^{*)}	
Length of the power cable	2 m	
Overvoltage category (in accordance with EN 61010-1)	transient overvoltages up to the values of overvoltage category II	
Air pollution degree (in accordance with EN 61010-1)	2	
Ambient conditions		
Noise emission	64 dB(A)	
Heat emission (with max. load)	6120 kJ/h	
Ambient temperature	5-40 °C (ideal range 16-26 °C)	
Degree of protection (in accordance with IEC 60529)	IP20	
Relative humidity	max. 80 % at temperatures of up to 31 °C, max. 50 % at 40 °C (decreasing in linear fashion in-between)	
Altitude	max. 4000 m	
Air pressure	> 610 mbar plus natural fluctuations in compressed-air	
Feed water connection		
Water quality	distilled or demineralised feed water in accordance with EN 13060	
Min. flow pressure	1.5 bar at 3 l/min	
Min. static water pressure	2 bar	
Max. static water pressure	10 bar	
Max. water consumption	0.74 l	0.83 l
Water temperature	5-35 °C	
Wastewater connection		
Max. throughflow volume	1.5 l/min	
Max. water temperature	98 °C	

^{*)} see type plate

15 Accessories and spare parts

All specified articles are available through specialist dealers.

Category	Article	Art. no.	
		Chamber depth 35 cm	Chamber depth 45 cm
Holders	Universal mount	ME22921	ME22922
Trays	Tray for universal mount	ME22923	ME22924
	Tray, flat	ME22925	ME22926
	Tray, narrow	ME01320	ME01310
Sterilization container with a single-use paper filter in accordance with EN 868-8 (depth x width x height)	15K (18 x 12 x 4.5 cm)	ME01151	
	15M (35 x 12 x 4.5 cm)	--	ME01152
	15G (35 x 12 x 8 cm)	--	ME01153
	17K (20 x 14 x 5 cm)	ME01171	
	17M (41 x 14 x 5 cm)	--	ME01172
	17G (41 x 14 x 9 cm)	--	ME01173
	23M (42 x 16 x 6 cm)	--	ME01231
	23G (42 x 16 x 12 cm)	--	ME01232
	28M (32 x 16 x 6 cm)	ME01284	
	28G (32 x 16 x 12 cm)	ME01285	
MELAstore System	MELAstore Box 100 (31.2 x 19 x 4.6 cm)	ME01191	
	MELAstore Box 200 (31.2 x 19 x 6.5 cm)	ME01192	
Test body system	MELAcontrol Helix	ME01082	
	SteriHero Helix	ME01084	
	MELAcontrol Pro (incl. 40 indicator strips)	ME01075	
	MELAcontrol type 5 indicator (250 pcs.)	ME01077	
	MELAcontrol Bowie & Dick test	ME01078	
Water treatment	MELAdem 40 ion exchanger	ME01049	
	MELAdem 47 reverse osmosis unit	ME01047	
Documentation	CF card	ME01043	
	Card reader for CF card	ME01048	
	MELAprint 44 log printer	ME01144	
	Network adapter for MELAprint	ME40295	
	MELAprint 60 label printer	ME01160	
	Network cable, 2.5 m	ME15817	
	▶ Network cable (cross-over), 5 m	ME15814	
	Network cable, 10 m	ME15815	

Category	Article	Art. no.
Films	MELAfol+ (roll, 5 cm x 200 m)	ME00530
	MELAfol+ (roll, 7.5 cm x 200 m)	ME00531
	MELAfol+ (roll, 10 cm x 200 m)	ME00532
	MELAfol+ (roll, 15 cm x 200 m)	ME00533
	MELAfol+ (roll, 20 cm x 200 m)	ME00534
	MELAfol+ (roll, 25 cm x 200 m)	ME00535
	MELAfol+ (pouch, 5 cm x 25 cm, 1000 pcs.)	ME00536
	MELAfol+ (pouch, 7.5 cm x 25 cm, 1000 pcs.)	ME00537
	MELAfol+ (pouch, 10 cm x 25 cm, 1000 pcs.)	ME00538
	MELAfol+ (pouches with side gusset, 20 cm x 50 cm, 100 pcs.)	ME00539
Other	Water stop (leakage water detector with shut-off valve and probe)	ME01056
	Surface-mounted siphon	ME37410
	Chamber Protect chamber cleaning set	ME01081
	MELAG Care Oil Spray	ME22935
Category	Article	Art. no.
Spare parts	MELAG oil for door lock nut	ME27515
	Test gauge TR16 for door lock nut	ME27522
	Door gasket	ME45160
	Power cable C21 type E+F	ME21301
	Power cable C21 Type J (SEV) (Switzerland)	ME21302
	Power cable C21 Type I (GB2099-1/GB1002) (China)	ME21304
	Power cable C21 Type G (United Kingdom)	ME21305
	Power cable C21, type CEE16, blue	ME21306
	Power cable C21 Type K (Denmark)	ME21307
	Power cable C21 Type H (Israel)	ME21308
	Slide clips for Plus/Universal mounts (10 pcs.)	ME81235

Glossary

Accessory

Accessories are independent articles that are used with one or several medical devices. Accessories specifically and directly assist the intended purpose of the medical device.

Air leakage

An air leakage is a location through which air can pass in or out without this being desired. The verification of the leakage serves to prove that the volume of air ingress in the sterilization chamber during the vacuum phase does not exceed a value which would prevent steam penetration of the load and that the air leakage does not cause the possible contamination of the load during the drying phase.

AKI

AKI is the abbreviation for "Arbeitskreis Instrumentenaufbereitung" [Instrument Reprocessing Working Group].

Authorised technician

An authorised technician is a person intensively trained and authorised by MELAG who has sufficient specific device and technical knowledge to perform maintenance and installation work on MELAG devices. Only they may carry out this work.

Batch

The batch is the composition of items which has been subject to the same reprocessing procedure.

BfArM

BfArM is the abbreviation for "Bundesinstitut für Arzneimittel und Medizinprodukte" [Federal Institute for Drugs and Medical Devices] in Germany.

Bowie & Dick test

The Bowie & Dick test is a vapour penetration test with standard test package, see EN 285. This test is recognised in large-scale sterilization.

CF card

The CF card is a memory medium for digital data; Compact Flash is an official standard, i.e. these memory cards can be used in every device fitted with the corresponding slot. The CF card can be read by every device that supports the standard and where necessary, written on.

Competent personnel

Trained personnel in accordance with national specifications for the respective area of application (dentistry, medicine, podiatry, veterinary medicine, cosmetics, piercing, tattoo) with the following contents: knowledge of instruments, hygiene and microbiology, risk assessment and classification of medical devices and instrument reprocessing.

Component

A component is a part of a medical device, which is delivered with it but is not permanently connected to it. A component supports or achieves the intended purpose of the medical device for at least one use case. It is not an independent accessory or medical device.

Condensate

Condensate is a liquid (e.g. water) that emerges from the vapour state when cooled and thus separates.

Conductivity

Conductivity is the ability of a conductive chemical substance or mixture of substances to conduct or transfer energy or other substances or particles in space.

Corrosion

Corrosion is the chemical alteration or destruction of metallic materials by water and chemical substances.

Delay in boiling

Superheating is the phenomenon that it is possible under certain circumstances to heat liquids beyond their boiling point without them boiling. This condition is unstable. Low-level agitation can produce a large bubble within the shortest period; this can expand explosively.

Demineralised water

Demineralised water does not contain minerals that are found in normal spring or tap water. It is obtained from tap water by ion exchange and used as feed water.

DGSV

DGSV is the abbreviation for "Deutsche Gesellschaft für Sterilgutversorgung" [German Society for Sterile Supply]. The training guidelines of the DGSV are listed in DIN 58946, Part 6 as requirements for personnel.

DGUV Regulation 1

DGUV is the abbreviation for "Deutsche Gesetzliche Unfallversicherung" [German Statutory Accident Insurance]. The regulation 1 governs the principles of prevention.

DIN 58946-7

Standard for "Sterilization – Steam sterilizers – Part 7: Building requirements and requirements placed on the equipment and the operation of steam sterilizers in the health-care branch"

DIN 58953

Standard for "Sterilization – Sterile supply"

Distilled water

Distilled water is largely free of salts, organic substances, and micro-organisms. It is obtained by distillation (evaporation and subsequent condensation) from normal tap water or pre-purified water. Distilled water is used as feed water.

Double jacket steam generator

The double jacket steam generator is used for rapid steam generation outside the sterilization chamber and ensures uniform temperature distribution in the chamber wall.

Dynamic pressure test

The dynamic pressure test serves to prove that the rate of pressure variations in the sterilization chamber during a sterilization cycle does not exceed a particular value which could result in the damage of the packaging material, see EN 13060.

Empty chamber test

The empty chamber test is a test without a load and is performed to assess the performance of the steam sterilizer without the influence of a load. This allows the temperatures and pressures obtained to be checked against the intended settings, see EN 13060.

EN 13060

Standard for "Small steam sterilizers"

EN ISO 11140-1

Standard for "sterilization of products for use in medical treatment – chemical indicators – part 1: General requirements"

EN ISO 11607-1

Standard for "packaging for medical devices to be sterilized in the final packaging – Part 1: Requirements placed on materials, sterile barrier systems, and packaging systems"

Equipment

Equipment is an article that can be used with the medical device, however, it is not necessary for assisting and/or achieving the intended purpose of the medical device. It is not an independent accessory or medical device.

Evacuation

Evacuation is the creation of a vacuum in a vessel.

Feed water

Feed water is required to generate the water vapour for sterilization; guide values for water quality in accordance with EN 285 or EN 13060.

Fractionated vacuum procedure

The fractionated vacuum process is a technical process of steam sterilization. This procedure includes the repeated evacuation of the sterilization chamber in alternation with steam injection.

FTP

FTP (File Transfer Protocol) is a data transmission procedure serving to transfer data from the Internet. This data can include programs, files or even information. Special FTP programs (FTP clients) serve to load the data onto a server.

KRINKO

KRINKO is the abbreviation for "Kommission für Krankenhaushygiene und Infektionsprävention"

[Commission for Hospital Hygiene and Infection Prevention] at the Robert Koch Institute in Germany.

Load

The load includes products, equipment, or materials that are reprocessed together in one operating cycle.

Medical device

Medical device means any instrument, apparatus, appliance, software, implant, reagent, material or other article intended by the manufacturer to be used, alone or in combination, for human beings for one or more of the specific medical purposes in accordance with Regulation (EU) 2017/745 Article 1, Paragraph 4.

Mixed loads

The load within a batch includes both packed and unpacked products.

Multiple wrapping

The load is sealed in a double layer of film, instruments wrapped in foil are additionally planed in a container or containers wrapped in textiles.

Network cable (crossover)

A crossover network cable connects two computers (through network cards) directly without the use of a hub/switch. This type of connection corresponds with the network connection of the steam sterilizer in the (practice) network. The crossover cable does not run in parallel between the connectors, rather certain wires are crossed.

Porous

Porous describes the property of materials (e.g. textiles) to allow water, air, or other liquids to pass through.

Porous full load

The porous full load specification serves to prove that the values set at the control satisfy the necessary sterilization conditions in porous loads with the maximum density for whose sterilization a steam sterilizer is designed to EN 13060.

Porous partial load

The porous partial load specification serves to prove that the values set on the control allow steam to enter the pre-determined test package quickly and equally, see EN 13060.

Pre-heating time

The preheating time is the time required for preheating the double-jacket steam generator after starting up the device or after starting a sterilization program before the sterilization process starts. The duration depends on the sterilization temperature.

Process evaluation system

The process evaluation system (also known as "self-monitoring system") monitors itself and compares sensors during running programs.

Product with narrow lumen

A product with narrow lumen is either open on one side or on both sides. The following applies for an article open on one side: $1 \leq L/D \leq 750$ and $L \leq 1500$ mm. The following applies for an article open on both sides: $2 \leq L/D \leq 1500$ and $L \leq 3000$ mm and which does not correspond to the hollow body B (L = hollow body length, D = hollow body diameter), see EN 13060.

Qualified electrician

The qualified electrician has the suitable technical training, knowledge, and experience to recognise and avoid hazards that can be caused by electricity, see IEC 60050 or for Germany VDE 0105-100.

Reprocessing

Reprocessing is a measure to prepare a new or used healthcare device for its intended purpose. Reprocessing includes cleaning, disinfection, sterilization and similar procedures.

RKI

RKI is the abbreviation for "Robert Koch-Institut" [Robert Koch Institute]. The Robert Koch Institute is the central institution for the detection, prevention, and control of diseases, especially infectious diseases.

Simple hollow bodies

A simple hollow body is either open on one side or both sides, see EN 13060. The following applies for an article open on one side: $1 \leq L/D \leq 5$ and $D \geq 5$ mm. The following applies for an article open on both sides: $2 \leq L/D \leq 10$ and $D \geq 5$ (L = hollow body length, D = hollow body diameter).

Single wrapping

The load is wrapped once in a sterile barrier system (e.g. transparent sterilization package). The opposite of this is multiple wrapping.

Soft sterilization packaging

A soft sterilization wrapping is a paper bag or a transparent sterilization package.

Solid

Solid describes the property of a product that is made of non-porous material that has no bulges or other design features that offer greater or equal resistance to steam penetration than a simple hollow body.

Solid load

The solid load specification serves to prove that the necessary sterilization conditions have been reached within the entire load with the values set in the control. The load must represent the largest weight of solid instruments for whose sterilization a steam sterilizer is designed to EN 13060.

Sterile barrier system

The sterile barrier system is a minimum level of sealed packaging that prevents the entry of micro-organisms (e.g. sealed pouches, sealed reusable containers, folded sterilization wipes) and allows for the aseptic delivery of the product at the point of use.

Sterile material

Sterile goods are successfully sterilized (i.e. sterile) goods. Sterile goods are also referred to as batches.

Sterilization chamber

The sterilization chamber is the part of the steam sterilizer where the load is sterilized.

TCP

TCP (Transmission Control Protocol) designates a standard-protocol for a connection between computers and networks.

Vacuum

Colloquially, vacuum is a space free of matter. In the technical sense, it is a volume with reduced gas pressure (mostly air pressure).



MELAG Medizintechnik GmbH & Co. KG

Geneststr. 6-10

D-10829 Berlin

Germany

Email: info@melag.com

Web: www.melag.com

Original instructions

Responsible for content: MELAG Medizintechnik GmbH & Co. KG

We reserve the right to technical alterations